

SURGICAL

INSTRUMENTS CATALOGUE



TETRO SURGICAL

Manufacturers & Exporters of Dental, Surgical & Beautycare Instruments.

☎ +92 305 823 6257

✉ info@tetrosurgical.com 🌐 www.tetrosurgical.com

📍 Mohallah Muzaffar pur, Defence Road, Sialkot-Pakistan



TETRO SURGICAL

Manufacturers & Exporters of Dental, Surgical & Beautycare Instruments.

DIAGNOSTIC SETS



DIAGNOSTIC SET (ENT COMPLETE)

01-001

Consisting of Battery Handle (without Battery)

3 Ear Specula, 1 Nasel Specula,

2 Laryngeal mirrors with Holder

1 Tongue Depressor Holder, 1 Bulb



OTOSCOPE Set

01-002

Consisting of Battery Handle

(without Battery) 3 Ear Specula, 1 Bulb



TETRO SURGICAL

Manufacturers & Exporters of Dental, Surgical & Beautycare Instruments.

Diagnostic Sets

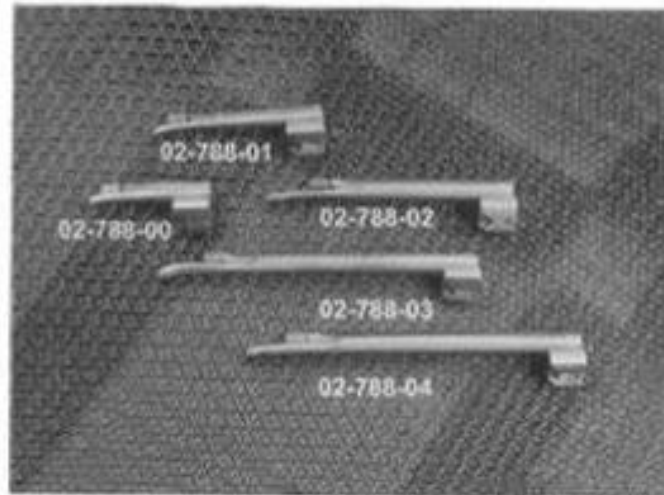

Miller



Miller
02-003
Laryngoscope
set



TETRO SURGICAL

Manufacturers & Exporters of Dental, Surgical & Beautycare Instruments.

Catheter Forceps



Magill
03-004 to 03-005



03-004
(20 cm)



03-005
(25 cm)



McIntosh
Laryngoscope Set
03-006

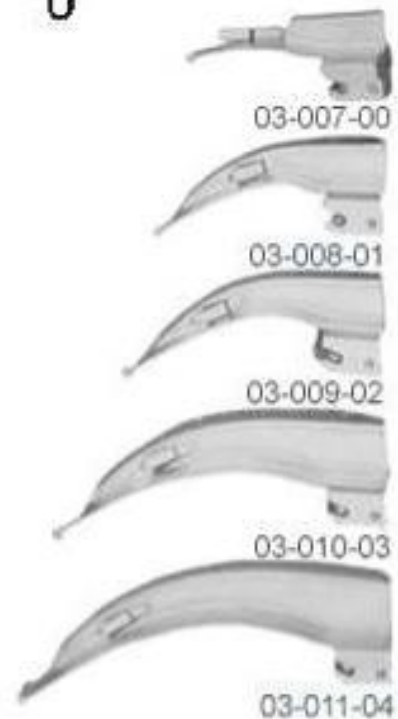

03-007-00

03-008-01

03-009-02

03-010-03

03-011-04

McIntosh



TETRO SURGICAL

Manufacturers & Exporters of Dental, Surgical & Beautycare Instruments.

Scalple Handler



1/1

1/1

1/1

1/1

1/1

1/1

1/1

04-012

04-013

04-014

04-015

04-016

Standard
04-017

04-018



TETRO SURGICAL

Manufacturers & Exporters of Dental, Surgical & Beautycare Instruments.

Operating Scissors



Standard
05-019 to 05-026



Str

- 05-019 (10cm)
- 05-020 (11cm)
- 05-021 (13cm)
- 05-022 (14cm)
- 05-023 (15cm)
- 05-024 (16cm)
- 05-025 (18cm)
- 05-026 (20cm)



Standard
05-027 to 05-034



Cur

- 05-027 (10cm)
- 05-028 (11cm)
- 05-029 (13cm)
- 05-030 (14cm)
- 05-031 (15cm)
- 05-032 (16cm)
- 05-033 (18cm)
- 05-034 (20cm)



Brazil
05-035 to 05-037

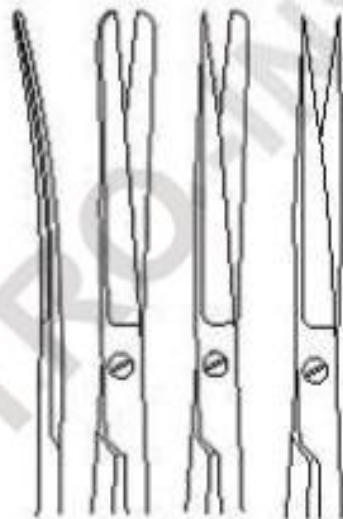

- 05-035 (14.5cm)
- 05-036 (14.5cm)
- 05-037 (14.5cm)



Brazil
05-038 to 05-040

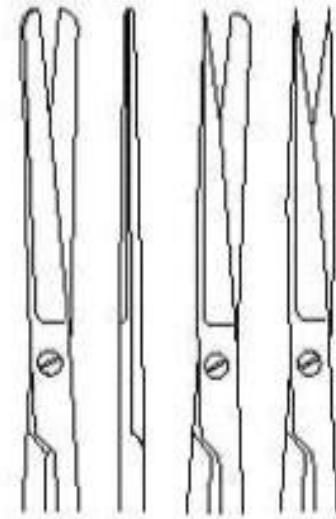

- 05-038 (14.5cm)
- 05-039 (14.5cm)
- 05-040 (14.5cm)



TETRO SURGICAL

Manufacturers & Exporters of Dental, Surgical & Beautycare Instruments.

Operating Scissors



1/1

Standard

06-041 to 06-047



Cur

- 06-041 (11.5cm)
- 06-042 (13.5cm)
- 06-043 (14.5cm)
- 06-044 (15.5cm)
- 06-045 (16.5cm)
- 06-046 (18.5cm)
- 06-047 (20.5cm)



Standard

06-048 to 06-055

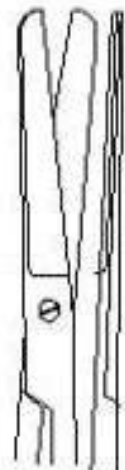

Str

- 06-048 (10.5cm)
- 06-049 (11.5cm)
- 06-050 (13.5cm)
- 06-051 (14.5cm)
- 06-052 (15.5cm)
- 06-053 (16.5cm)
- 06-054 (18.5cm)
- 06-055 (20.5cm)



Standard

06-056 to 06-062



Cur

- 06-056 (11.5cm)
- 06-057 (13.5cm)
- 06-058 (14.5cm)
- 06-059 (15.5cm)
- 06-060 (16.5cm)
- 06-061 (17.5cm)
- 06-062 (18.5cm)



Standard

06-063 to 06-070

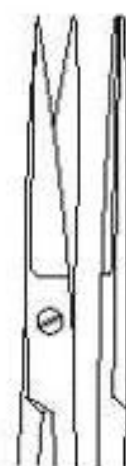

Str

- 06-063 (10.5cm)
- 06-064 (11.5cm)
- 06-065 (13.5cm)
- 06-066 (14.5cm)
- 06-067 (15.5cm)
- 06-068 (16.5cm)
- 06-069 (18.5cm)
- 06-070 (20.5cm)



TETRO SURGICAL

Manufacturers & Exporters of Dental, Surgical & Beautycare Instruments.

Operating Scissors



Metzenbaum

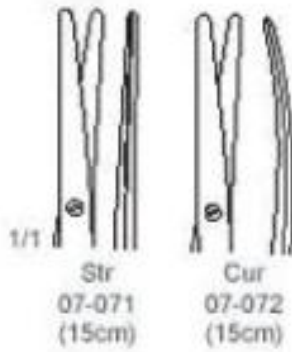

1/1

Str
07-071
(15cm)

Cur
07-072
(15cm)



Metzenbaum

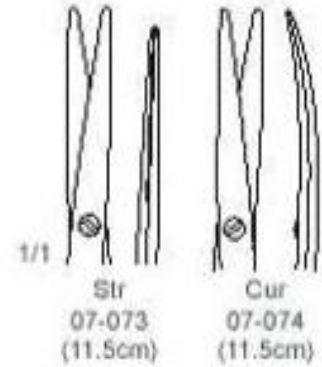

1/1

Str
07-073
(11.5cm)

Cur
07-074
(11.5cm)



Sims

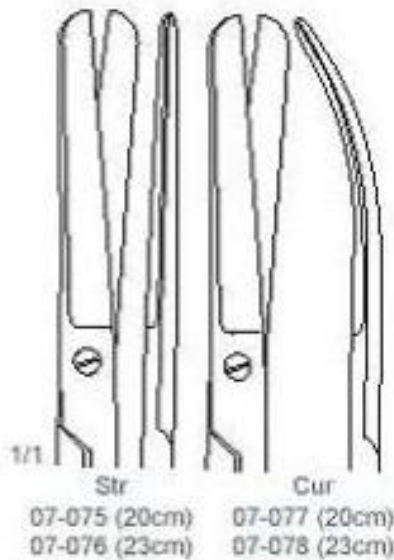

1/1

Str
07-075 (20cm)
07-076 (23cm)

Cur
07-077 (20cm)
07-078 (23cm)



Kelly

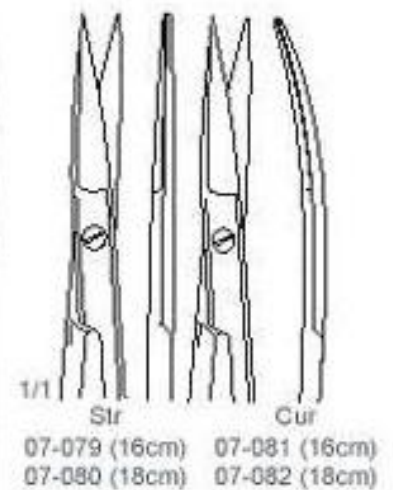

1/1

Str
07-079 (16cm)
07-080 (18cm)

Cur
07-081 (16cm)
07-082 (18cm)



TETRO SURGICAL

Manufacturers & Exporters of Dental, Surgical & Beautycare Instruments.

Operating Scissors



Wertheim
08-083 to 08-085

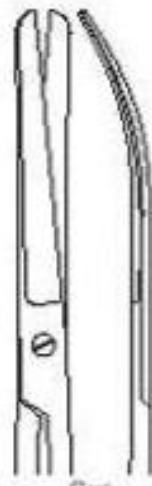

Cur
08-083 (14cm)
08-084 (19cm)
08-085 (22cm)



Mayo-Harrington
08-086 to 08-088

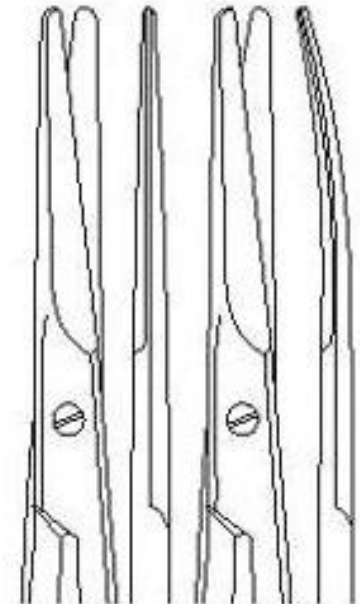

Str Cur
08-086 (22cm) 08-087 (22cm)
08-088 (30cm)



Mayo-Noble
08-089 to 08-090

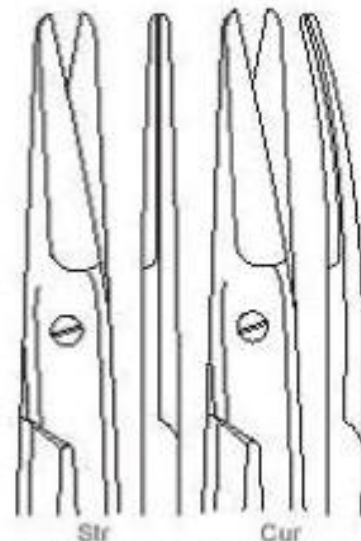

Str Cur
08-089 (17cm) 08-090 (17cm)



Mayo-Stillé
08-091 to 08-096

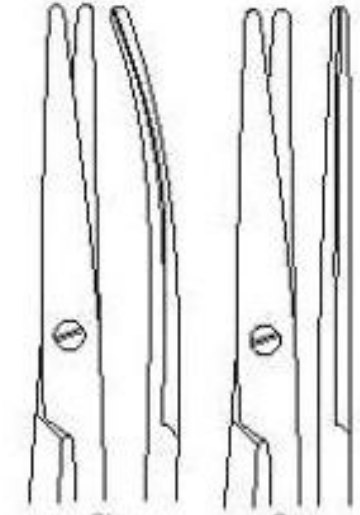

Str Cur
08-091 (16cm) 08-094 (16cm)
08-092 (19cm) 08-095 (19cm)
08-093 (21cm) 08-096 (21cm)



TETRO SURGICAL

Manufacturers & Exporters of Dental, Surgical & Beautycare Instruments.

Operating Scissors



- 09-097 (18cm)
- 09-098 (20cm)
- 09-099 (23cm)
- 09-100 (25cm)
- 09-101 (28cm)
- 09-102 (30cm)

Metzenbaum-Nelson
09-097 to 09-102

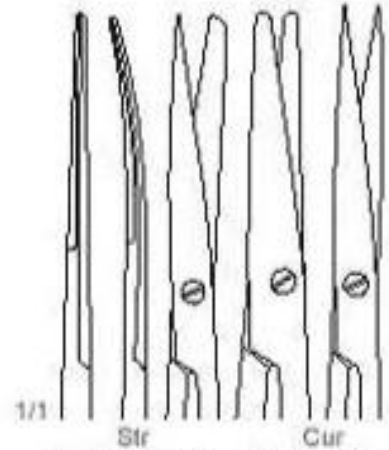

- 09-103 (14cm)
- 09-104 (14cm)
- 09-105 (14cm)
- 09-106 (14cm)
- 09-107 (14cm)
- 09-108 (14cm)

Metzenbaum
09-103 to 09-108



- 09-109 (18cm)
- 09-110 (20cm)
- 09-111 (23cm)
- 09-112 (25cm)
- 09-113 (28cm)
- 09-114 (30cm)

Metzenbaum-Nelson
09-109 to 09-114



- 09-115 (18cm)
- 09-116 (20cm)
- 09-117 (23cm)
- 09-118 (25cm)
- 09-119 (28cm)
- 09-120 (30cm)

Metzenbaum-Nelson
09-115 to 09-120



TETRO SURGICAL

Manufacturers & Exporters of Dental, Surgical & Beautycare Instruments.

Dissecting & Fine Scissors

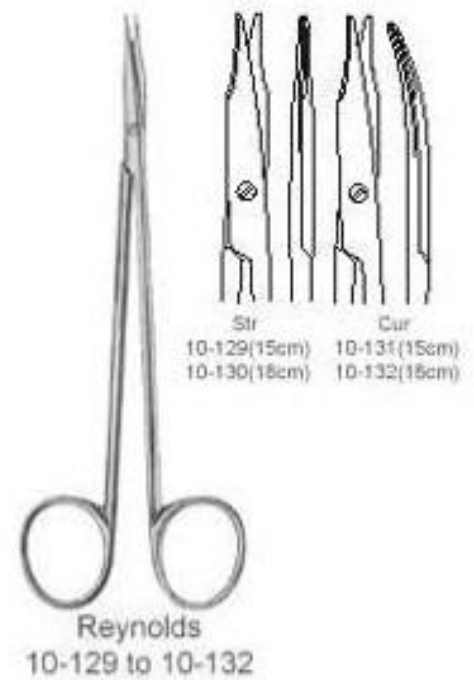
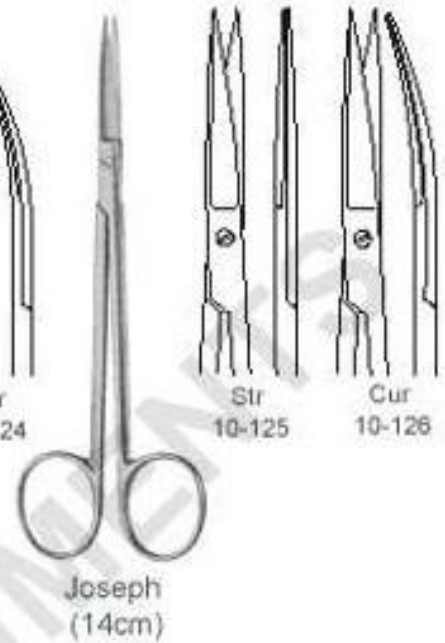
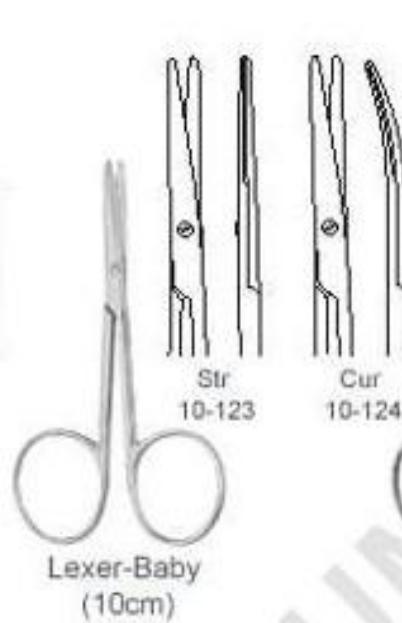



TETRO SURGICAL

Manufacturers & Exporters of Dental, Surgical & Beautycare Instruments.

Dissecting & Fine Scissors



Beebee
11-133 to 11-135

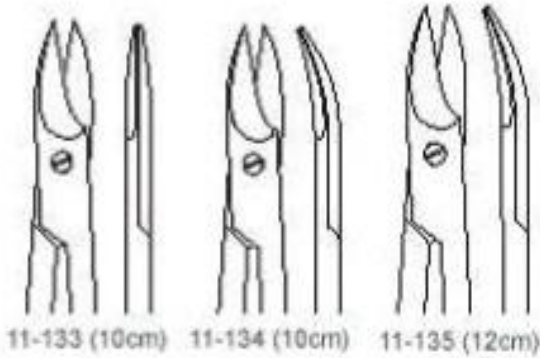

11-133 (10cm) 11-134 (10cm) 11-135 (12cm)



Universal
11-136
(12cm)

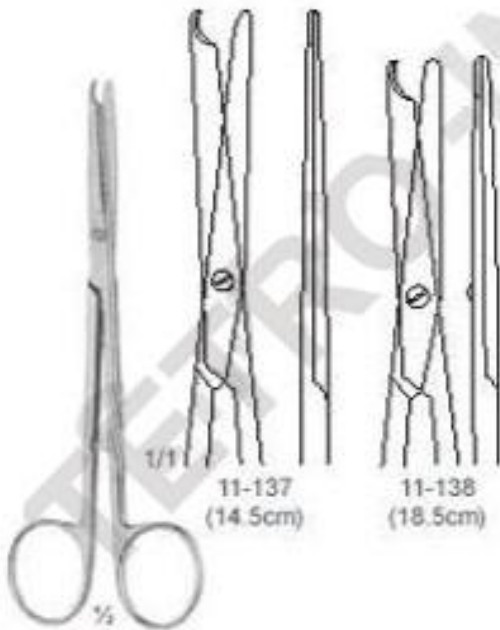

Buck
11-137 to 11-138



Littauer
11-139
(14cm)

Spencer
11-140
(9cm)

Spencer
11-141
(13cm)



TETRO SURGICAL

Manufacturers & Exporters of Dental, Surgical & Beautycare Instruments.

Ligature, Wire Cutting & Gum Scissors



1/2
Mod. USA
12-143
(10.5cm)



1/1



1/2
Busch
12-142
(16cm)



1/2
Schuhmacher
12-143/A
(15.5cm)



TETRO SURGICAL

Manufacturers & Exporters of Dental, Surgical & Beautycare Instruments.

Dissecting & Fine Scissors



13-144
(20cm)



Lister
13-145 (9cm)
13-146 (14cm)
13-147 (18cm)
13-148 (20cm)



Utility
13-149 (15cm)
13-150 (18cm)



Bruns
13-151 (24cm)



Stille
13-152 (20cm)
13-153 (22cm)



TETRO SURGICAL

Manufacturers & Exporters of Dental, Surgical & Beautycare Instruments.

Micro Gum Scissors

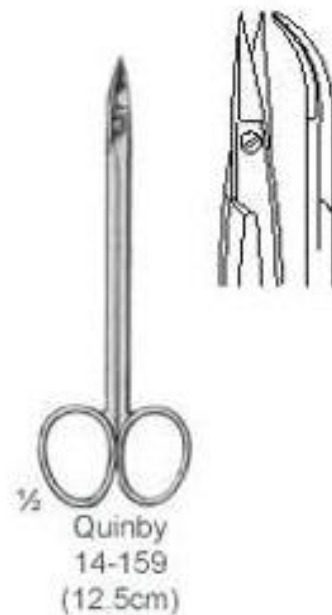
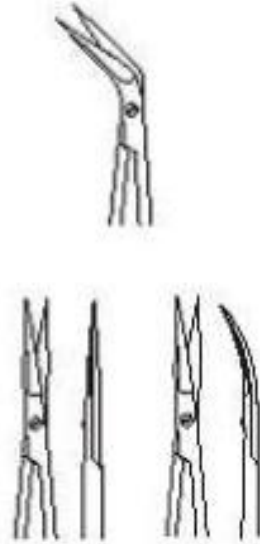



TETRO SURGICAL

Manufacturers & Exporters of Dental, Surgical & Beautycare Instruments.

Artery Forceps



Halsted-Mosquito
15-160 to 15-167

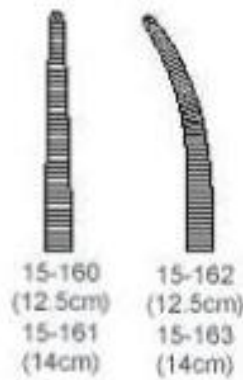

15-160 (12.5cm) 15-162 (12.5cm)
15-161 (14cm) 15-163 (14cm)

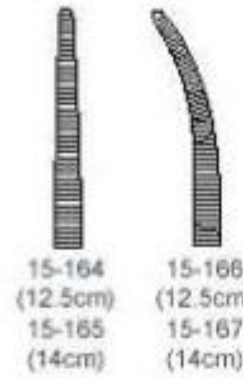

15-164 (12.5cm) 15-166 (12.5cm)
15-165 (14cm) 15-167 (14cm)



Halsted-Mosquito
15-168 to 15-174

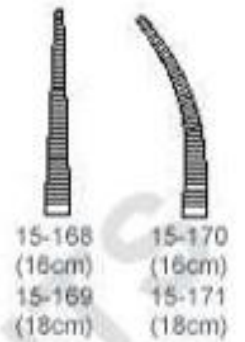

15-168 (16cm) 15-170 (16cm)
15-169 (18cm) 15-171 (18cm)

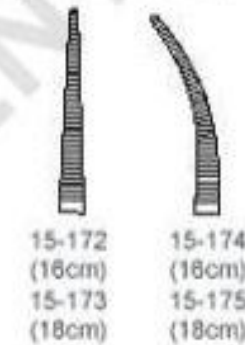

15-172 (16cm) 15-174 (16cm)
15-173 (18cm) 15-175 (18cm)



Mosquito
15-176 to 15-183

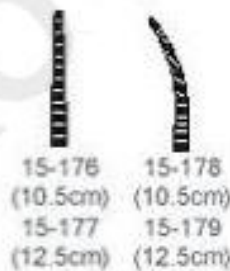

15-176 (10.5cm) 15-178 (10.5cm)
15-177 (12.5cm) 15-179 (12.5cm)

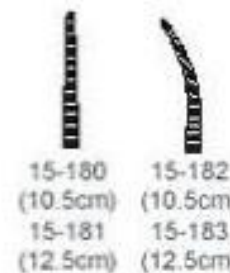

15-180 (10.5cm) 15-182 (10.5cm)
15-181 (12.5cm) 15-183 (12.5cm)



Crile
15-184 to 15-185

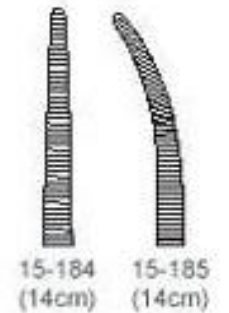

15-184 (14cm) 15-185 (14cm)



TETRO SURGICAL

Manufacturers & Exporters of Dental, Surgical & Beautycare Instruments.

Artery Forceps

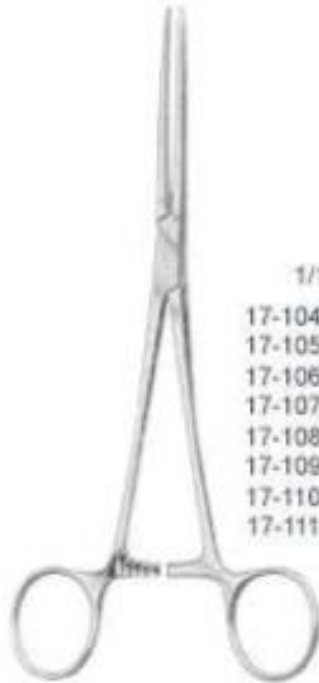

Pean (Rochester)
17-104 to 17-119

1/1

- | | |
|---------------|---------------|
| 17-104 (14cm) | 17-112 (14cm) |
| 17-105 (16cm) | 17-113 (16cm) |
| 17-106 (18cm) | 17-114 (18cm) |
| 17-107 (20cm) | 17-115 (20cm) |
| 17-108 (22cm) | 17-116 (22cm) |
| 17-109 (24cm) | 17-117 (24cm) |
| 17-110 (26cm) | 17-118 (26cm) |
| 17-111 (28cm) | 17-119 (28cm) |



Kocher (Rochester)
17-120 to 17-144

1/1

- | | |
|---------------|---------------|
| 17-120 (14cm) | 17-128 (14cm) |
| 17-121 (16cm) | 17-129 (16cm) |
| 17-122 (18cm) | 17-130 (18cm) |
| 17-123 (20cm) | 17-131 (20cm) |
| 17-124 (22cm) | 17-132 (22cm) |
| 17-125 (24cm) | 17-133 (24cm) |
| 17-126 (26cm) | 17-134 (26cm) |
| 17-127 (30cm) | 17-135 (30cm) |



Adson
17-136 to 17-137
(18.5cm)

1/1

- | | |
|--------|--------|
| 17-136 | 17-137 |
|--------|--------|



Pean
17-138 to 17-143

- | | |
|---------------|---------------|
| 17-138 (13cm) | 17-141 (13cm) |
| 17-139 (14cm) | 17-142 (14cm) |
| 17-140 (16cm) | 17-143 (16cm) |



TETRO SURGICAL

Manufacturers & Exporters of Dental, Surgical & Beautycare Instruments.

Artery Forceps



Pean (Rochester)
17-104 to 17-119

1/1

- 17-104 (14cm)
- 17-105 (16cm)
- 17-106 (18cm)
- 17-107 (20cm)
- 17-108 (22cm)
- 17-109 (24cm)
- 17-110 (26cm)
- 17-111 (28cm)



- 17-112 (14cm)
- 17-113 (16cm)
- 17-114 (18cm)
- 17-115 (20cm)
- 17-116 (22cm)
- 17-117 (24cm)
- 17-118 (26cm)
- 17-119 (28cm)



Kocher (Rochester)
17-120 to 17-144

1/1

- 17-120 (14cm)
- 17-121 (16cm)
- 17-122 (18cm)
- 17-123 (20cm)
- 17-124 (22cm)
- 17-125 (24cm)
- 17-126 (26cm)
- 17-127 (30cm)



- 17-128 (14cm)
- 17-129 (16cm)
- 17-130 (18cm)
- 17-131 (20cm)
- 17-132 (22cm)
- 17-133 (24cm)
- 17-134 (26cm)
- 17-135 (30cm)



Adson
17-136 to 17-137
(18.5cm)

1/1

17-136



17-137



Pean
17-138 to 17-143



- 17-138 (13cm)
- 17-139 (14cm)
- 17-140 (16cm)
- 17-141 (13cm)
- 17-142 (14cm)
- 17-143 (16cm)



TETRO SURGICAL

Manufacturers & Exporters of Dental, Surgical & Beautycare Instruments.

Artery Forceps

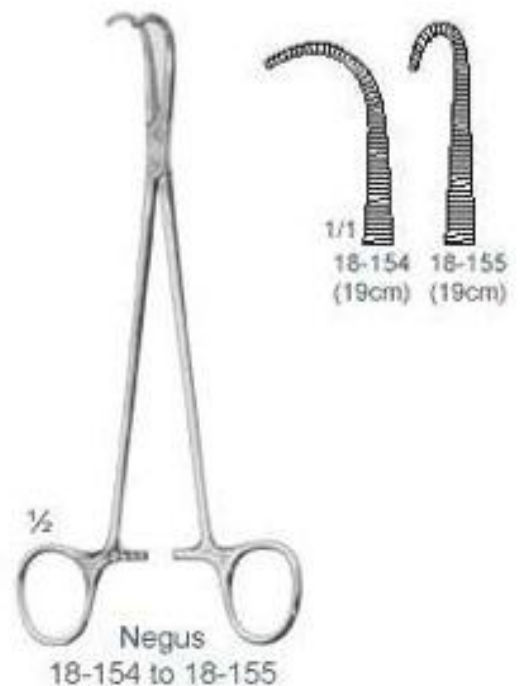
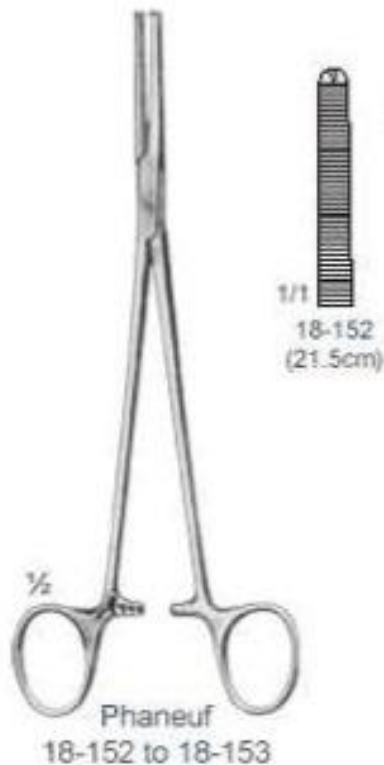
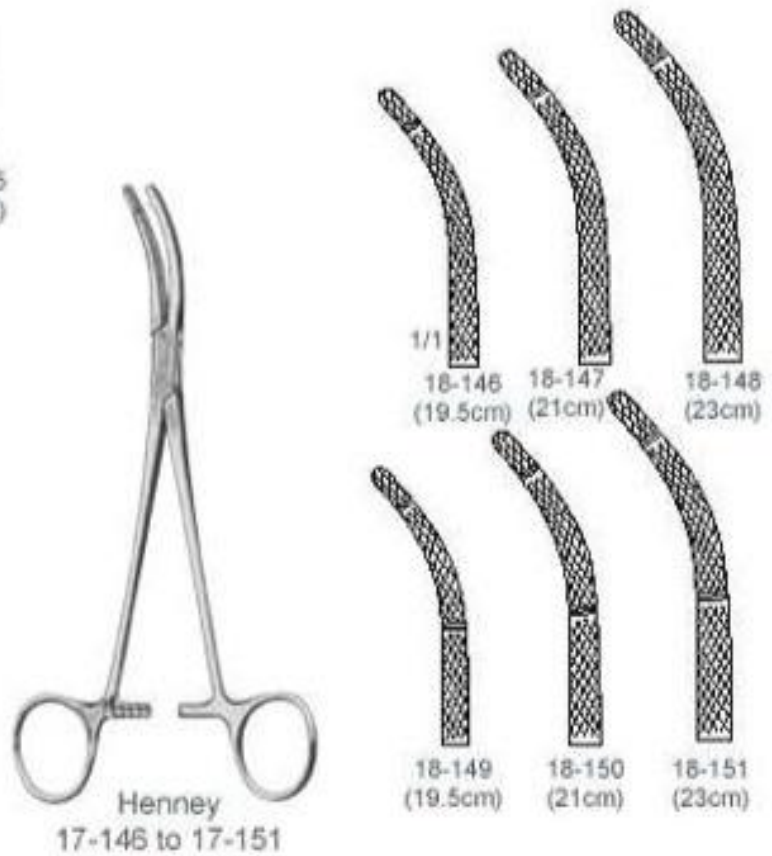
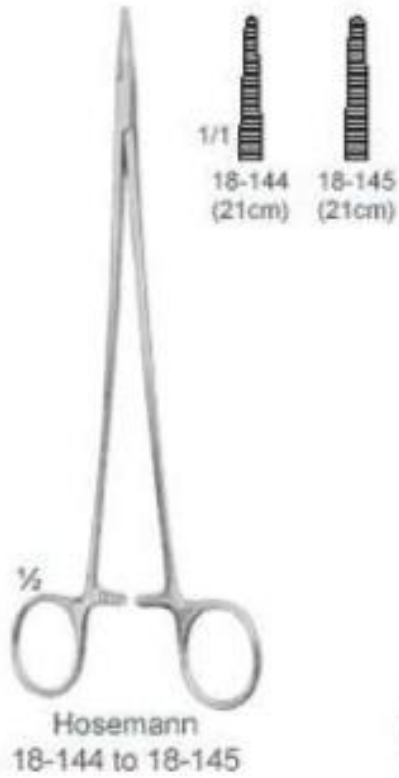



TETRO SURGICAL

Manufacturers & Exporters of Dental, Surgical & Beautycare Instruments.

Towel Forceps



Schaedel
19-156
(9cm)



Jones
19-157
(5cm)
19-158
(9cm)



Lorma
19-159
(10cm)
19-160
(13cm)



Tohoku
19-161
(10cm)
19-162
(13cm)



19-163
(11cm)
19-164
(13cm)

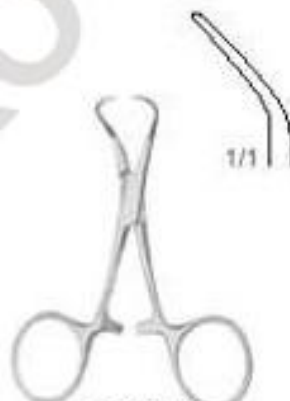

Backhaus
19-165 (8 cm)
19-166 (11cm)
19-167 (13cm)
19-168 (15cm)



19-169
(11cm)



Roeder
19-170
(13cm)
19-171
(15cm)



TETRO SURGICAL

Manufacturers & Exporters of Dental, Surgical & Beautycare Instruments.

Tissue & Organ Holding Forceps



Allis-Adair
20-172
(15cm)



Boys-Allis
20-173
(15cm)



Allis-Baby
20-174
(12cm)

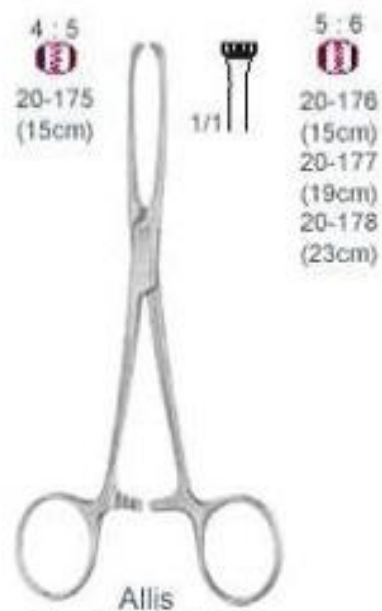

Allis
20-175 to 20-178



TETRO SURGICAL

Manufacturers & Exporters of Dental, Surgical & Beautycare Instruments.

Tissue & Organ Holding Forceps



Babcock
21-179 to 21-182



1/1
21-179
(16 mm)



21-180
(18 mm)



21-181
(20 mm)



21-182
(24 mm)



Duval
21-183 to 21-184



1/1
21-183
(20cm)



21-184
(23cm)



TETRO SURGICAL

Manufacturers & Exporters of Dental, Surgical & Beautycare Instruments.

Lamina Spreaders

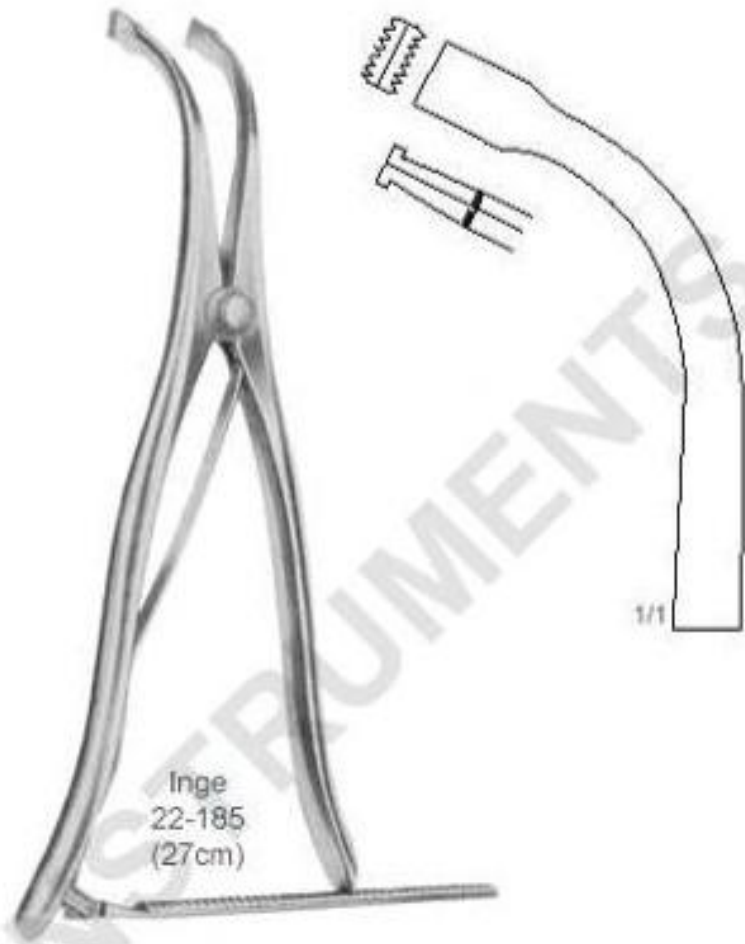

Cloward
22-186
(16cm)

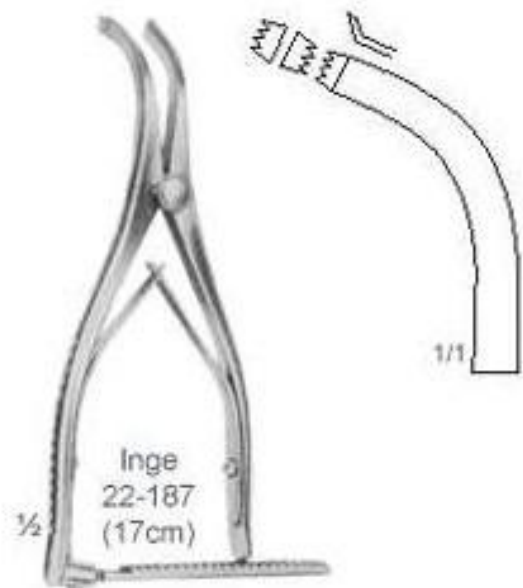



TETRO SURGICAL

Manufacturers & Exporters of Dental, Surgical & Beautycare Instruments.

Polypus & Sponge Holding Forceps



1/2
Foerster
23-188
(25cm)



1/1



23-188



23-188/A



1/2
Rampley
23-189
(25cm)



1/1



1/2
Bozemann-Douglas
23-190
(26cm)

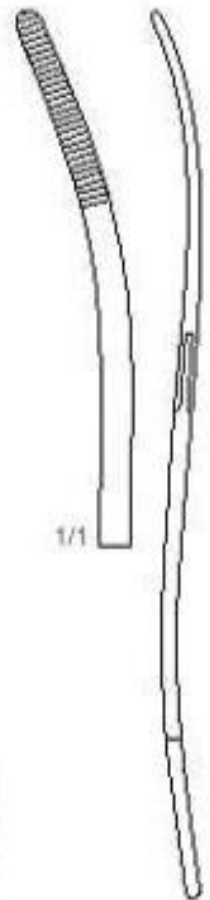

1/1



TETRO SURGICAL

Manufacturers & Exporters of Dental, Surgical & Beautycare Instruments.

Sponge Holding Forceps



Foerster
24-191 to 24-198

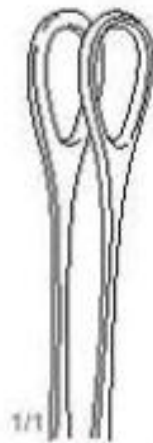

1/1
24-191
(25cm)



24-192
(18cm)
24-193
(20cm)
24-194
(25cm)



24-195
(25cm)



24-196
(18cm)
24-197
(20cm)
24-198
(25cm)



TETRO SURGICAL

Manufacturers & Exporters of Dental, Surgical & Beautycare Instruments.

Clip Applying Forceps

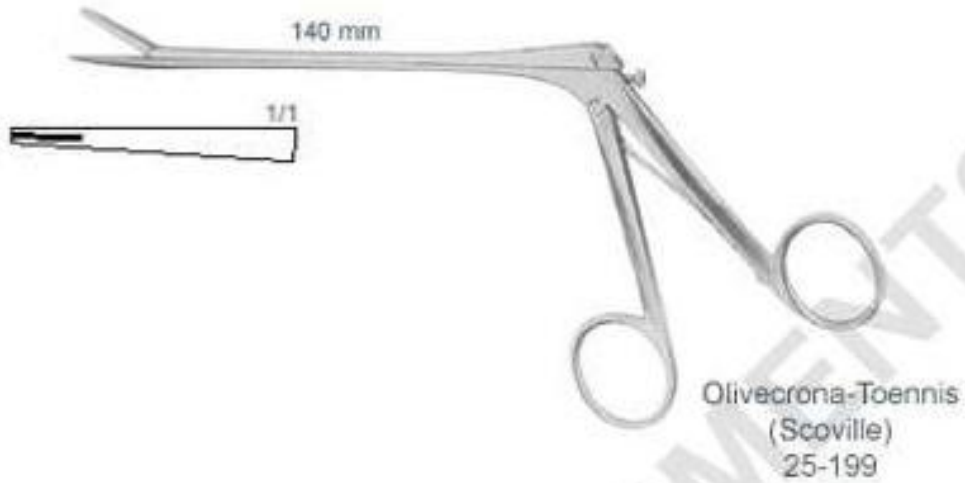

Mckenzie
25-200 (15cm)
25-201 (19cm)



Mckenzie
25-202 (15cm)
25-203 (19cm)

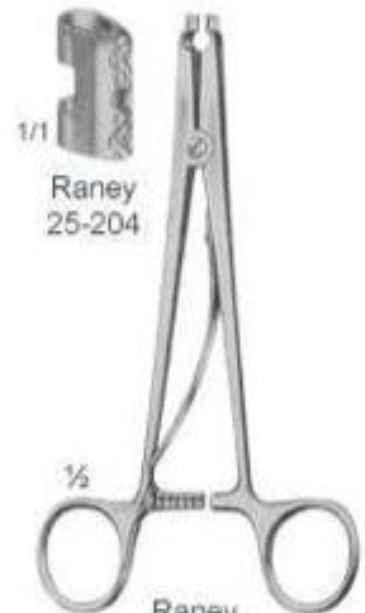



TETRO SURGICAL

Manufacturers & Exporters of Dental, Surgical & Beautycare Instruments.

Tissue & Organ Holding Forceps



Lovelace
26-206
(20cm)



1/1



Lovelace
26-207
(20cm)



1/1



Collin
26-208
(14cm)



1/1



Collin
26-209
(16cm)



1/1

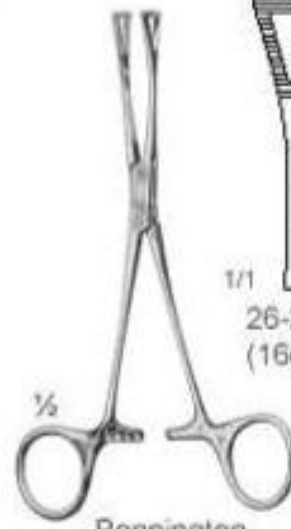

Pennington
26-210 to 26-211



1/1



26-210
(16cm)

26-211
(20cm)



TETRO SURGICAL

Manufacturers & Exporters of Dental, Surgical & Beautycare Instruments.

Dressing Forceps



1/1

- 27-212 (11cm)
- 27-213 (13cm)
- 27-214 (14.5cm)
- 27-215 (16cm)
- 27-216 (18cm)
- 27-217 (20cm)
- 27-218 (25cm)
- 27-219 (30cm)

STANDARD
27-212 to 27-1103



1/1

$\frac{1}{2}$
Taylor
27-220
(17cm)



1/1

- 27-221 (12cm)
- 27-222 (15cm)

$\frac{1}{2}$
Semken
27-221 to 27-222



- 27-223 (10cm)
- 27-224 (11cm)
- 27-225 (13cm)
- 27-226 (14.5cm)
- 27-227 (16cm)
- 27-228 (18cm)
- 27-229 (20cm)
- 27-230 (25cm)
- 27-231 (30cm)

Standard
27-223 to 27-231



1/1

Adson
27-232 to 27-233



27-232
(12cm)



27-233
(15cm)



1/1

$\frac{1}{2}$
McIndoe
27-234
(15cm)



TETRO SURGICAL

Manufacturers & Exporters of Dental, Surgical & Beautycare Instruments.

Tissue Forceps





TETRO SURGICAL

Manufacturers & Exporters of Dental, Surgical & Beautycare Instruments.

Needle Holders

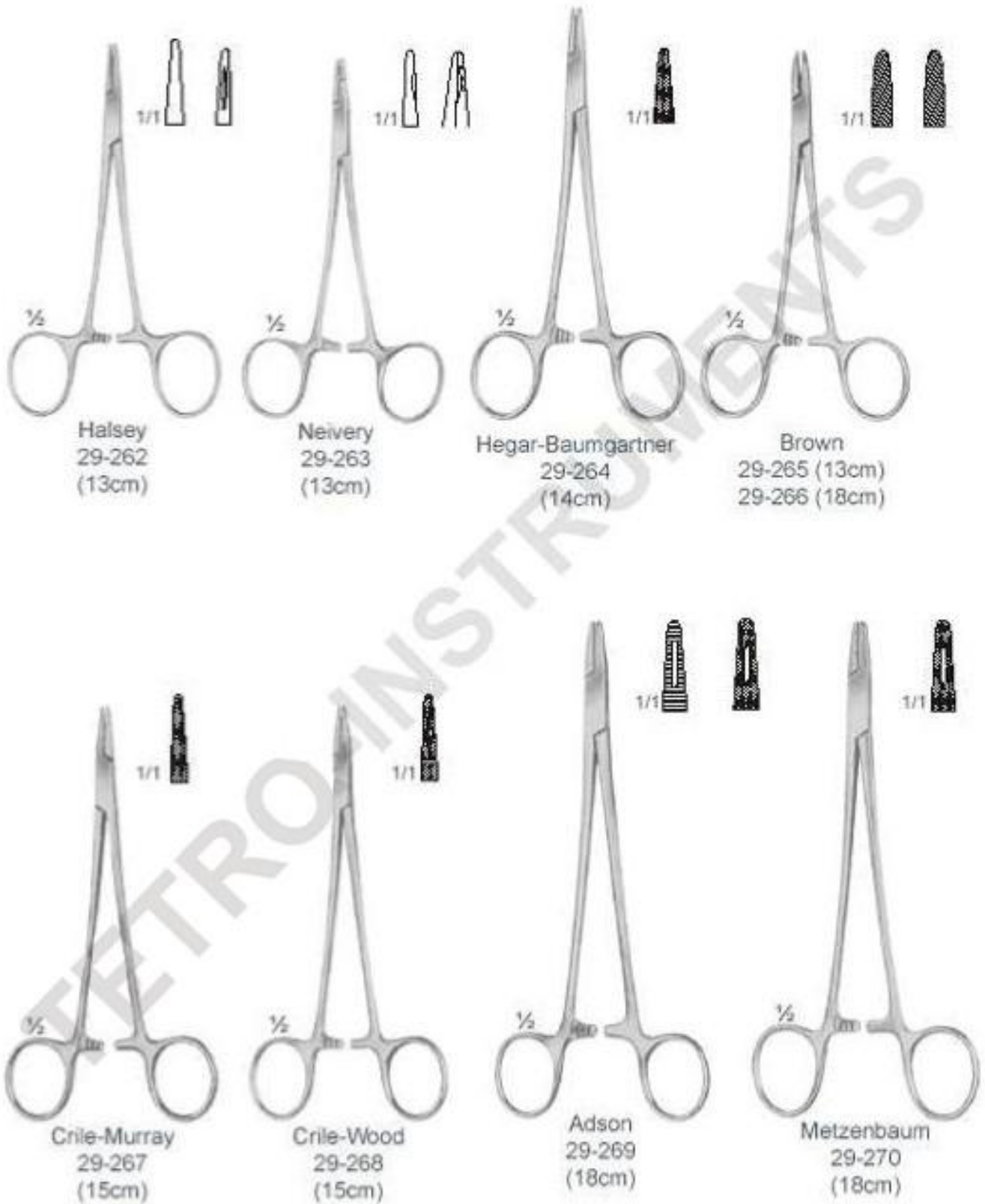



TETRO SURGICAL

Manufacturers & Exporters of Dental, Surgical & Beautycare Instruments.

Needle Holders





TETRO SURGICAL

Manufacturers & Exporters of Dental, Surgical & Beautycare Instruments.

Needle Holders



1/1

Crile
31-283
(15cm)



1/1

Toemmis
31-284
(18cm)



1/1

Stratte
31-285
(23cm)



1/1

Olsen-Hegar
31-286
(14cm)



1/1

Gillies
31-287
(16cm)



TETRO SURGICAL

Manufacturers & Exporters of Dental, Surgical & Beautycare Instruments.

Needle Holders





TETRO SURGICAL

Manufacturers & Exporters of Dental, Surgical & Beautycare Instruments.

Needle Holders





TETRO SURGICAL

Manufacturers & Exporters of Dental, Surgical & Beautycare Instruments.

Plaster Cast Instruments, Knives, Saws



Hennig
34-310
(28cm)

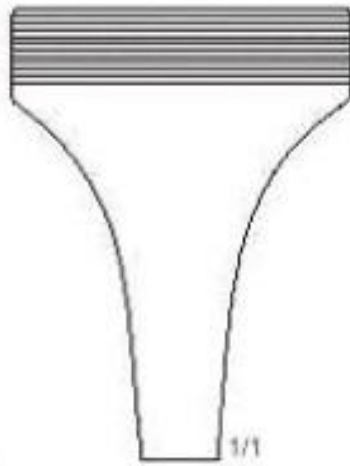

1/1



Wolff



1/1

34-311
(18cm)



34-312
(24cm)



1/2

Esmarch
34-313
(18cm)



1/2

Reiner
34-314
(18cm)



1/2

Hopkins
34-315
(20cm)



1/2

Engel
34-316
(14cm)



TETRO SURGICAL

Manufacturers & Exporters of Dental, Surgical & Beautycare Instruments.

Bone Holding Clamps Amputating & Resection Saws

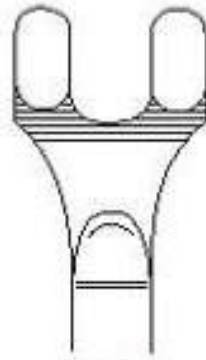
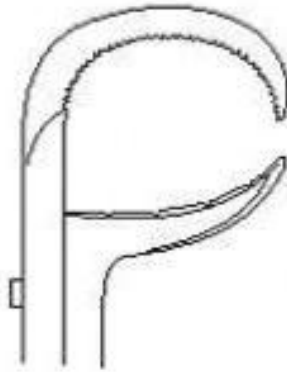

35-317
(18cm)



Spare Saw Blade
35-324 (12cm)
35-325 (15cm)



Charriere
35-323
(35cm)

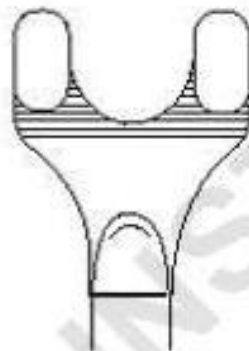

35-318
(20cm)

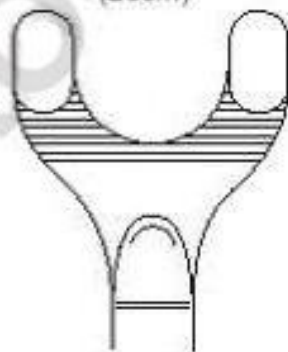

35-319
(22cm)



Gerster-Lowmann
35-317 to 35-319



1/4
Charriere
35-320 (27cm)
35-321 (30cm)



1/4
Satterlee
35-322 (31cm)



TETRO SURGICAL

Manufacturers & Exporters of Dental, Surgical & Beautycare Instruments.

Mallets, Gouges & Periostd Elevators

With Interchangeable
Ferrozell Faces
26 mm



½



Mead
36-326
(17 cm)



½



Partsch
36-327
(18 cm)



1/1

½

Langenbeck
36-328
(18cm)



1/1

½

Langenbeck
36-329
(19cm)



Hibbs
36-330
to
36-334



36-330
(6mm)

36-331
(13mm)

36-332
(19mm)

36-333
(25mm)

36-334
(32mm)



TETRO SURGICAL

Manufacturers & Exporters of Dental, Surgical & Beautycare Instruments.

Extension Bows Bone Wire Tightened

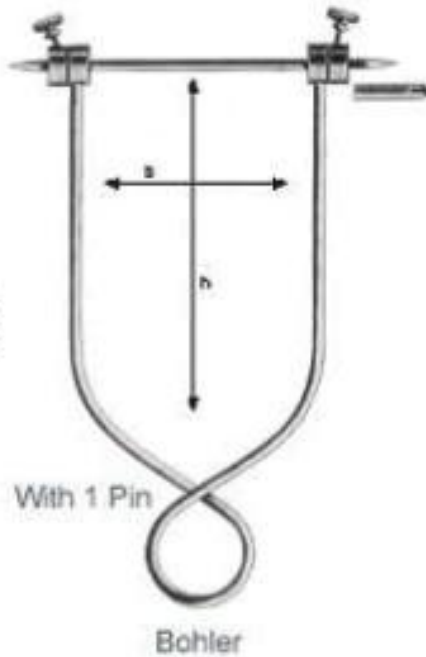
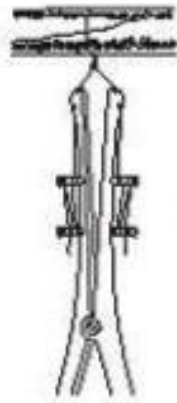

Bohler



Kirschner
37-340
(18.5cm) 0-40mm
37-341
(27cm) 35-200mm

37-337	6 1/4 x 3 1/2	16x9	For Arm
37-338	8 1/4 x 4 1/2	21x11	For Thigh & Knee
37-339	8" x 6"	21x15	For Femur & Knee



1/1

Demel
37-335
(28cm)



1/2

Louie
37-336
(21cm)



TETRO SURGICAL

Manufacturers & Exporters of Dental, Surgical & Beautycare Instruments.

Retractors



Farabeufr
38-342
(15cm)

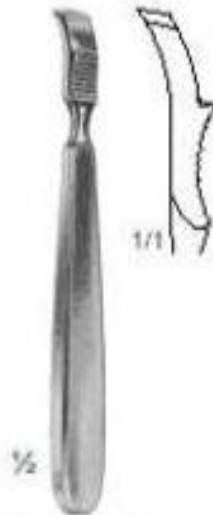

Farabeufr
38-343
(15cm)



Alexander
38-344
(20cm)



Doyen
38-345 to 38-348

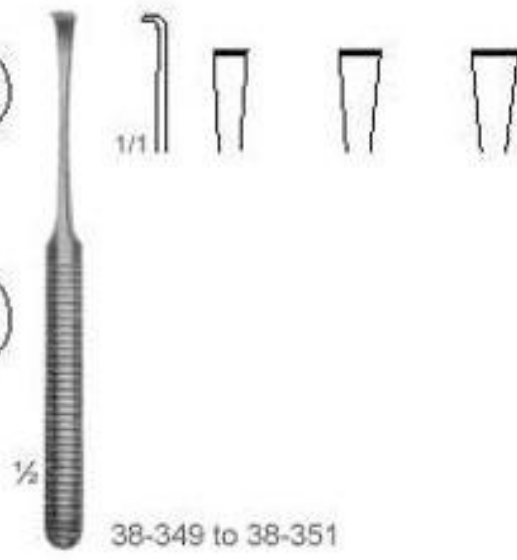

38-349 to 38-351



TETRO SURGICAL

Manufacturers & Exporters of Dental, Surgical & Beautycare Instruments.

Retractors



Mini-Langenbeck
38-352 to 39-355
(16cm)



Desmarres
38-356 to 39-361
(16cm)



38-362 to 39-365
(16cm)



38-366 to 39-371
(16cm)



38-372 to 39-373
(16cm)



TETRO SURGICAL

Manufacturers & Exporters of Dental, Surgical & Beautycare Instruments.

Retractors



40-374



40-375



40-378



40-379



1/1

40-376



40-377



1/1

40-380



40-381

40-374 to 40-377
(16cm)

40-378 to 40-381
(16cm)



1/1

40-382



40-383



1/1

40-384



40-385



1/1

40-386



40-387



40-388



40-389

1/2
Guthrie
40-382 to 40-383
(16cm)

Graefe
40-384 to 40-385
(16cm)

1/2
40-386 to 40-389
(16cm)



TETRO SURGICAL

Manufacturers & Exporters of Dental, Surgical & Beautycare Instruments.

Retractors



Gelpi-Loktite
41-390
(13cm)

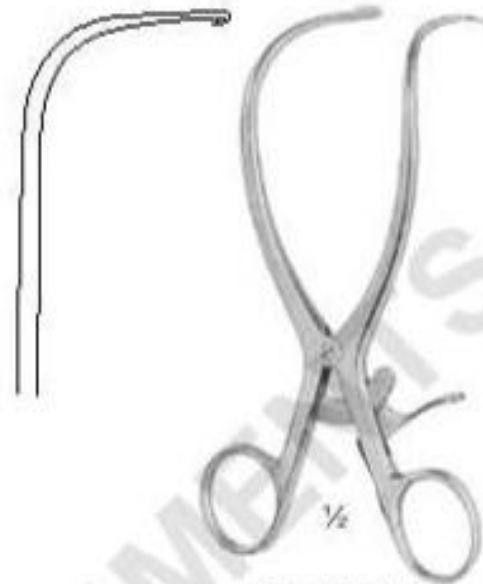

Gelpi-Seiletz
41-391
(15cm)



Gelpi-Loktite
41-392
(18cm)

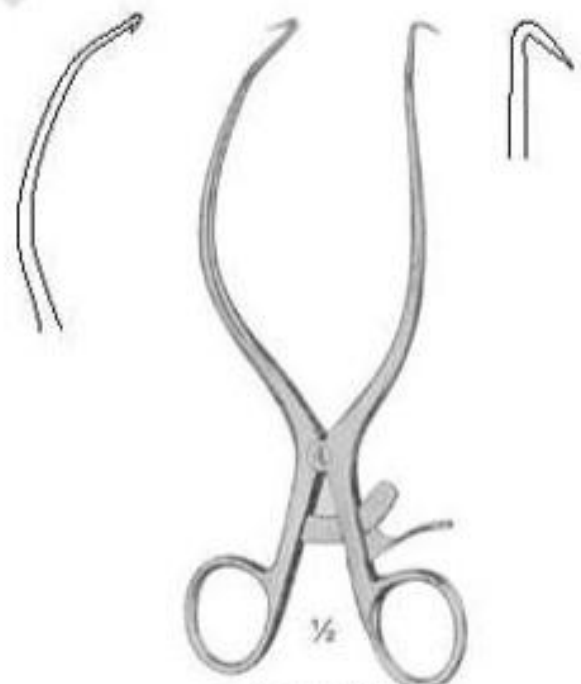

Gelpi-Loktite
41-393
(18cm)



Retractors



Weitlaner-Wulstein
42-394 to 42-395
(13cm)



42-394

1/1
42-395



Mollison
42-396
(15cm)



1/1



Adson
42-397 to 42-400
(26.5cm)



42-397

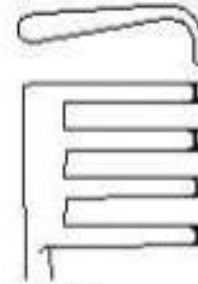

42-398



1/1
42-399

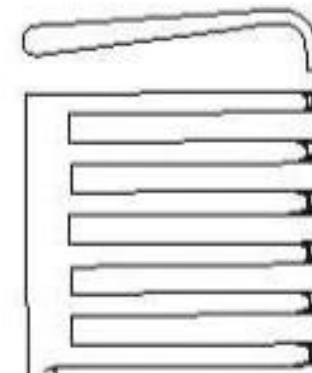

42-400



TETRO SURGICAL

Manufacturers & Exporters of Dental, Surgical & Beautycare Instruments.

Retractors





TETRO SURGICAL

Manufacturers & Exporters of Dental, Surgical & Beautycare Instruments.

Retractors





TETRO SURGICAL

Manufacturers & Exporters of Dental, Surgical & Beautycare Instruments.

Retractors



Isreei
45-411 to 44-414
(25cm)



1/2
45-411
(40x40mm)



1/2
45-412
(40x50mm)



1/2
45-413
(50x60mm)



1/2
45-414
(70x70mm)



1/2
Langenbeck
45-415 to 45-419
(22cm)





TETRO SURGICAL

Manufacturers & Exporters of Dental, Surgical & Beautycare Instruments.

Retractors





TETRO SURGICAL

Manufacturers & Exporters of Dental, Surgical & Beautycare Instruments.

Retractors

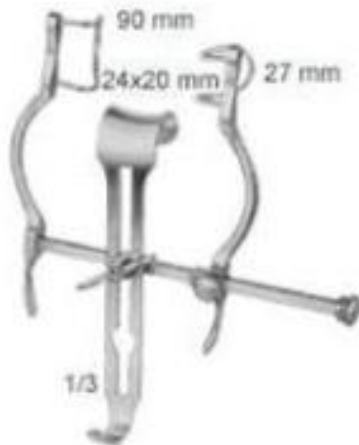

Balfour-Baby
47-427



Gosset
47-428



Balfour
47-429

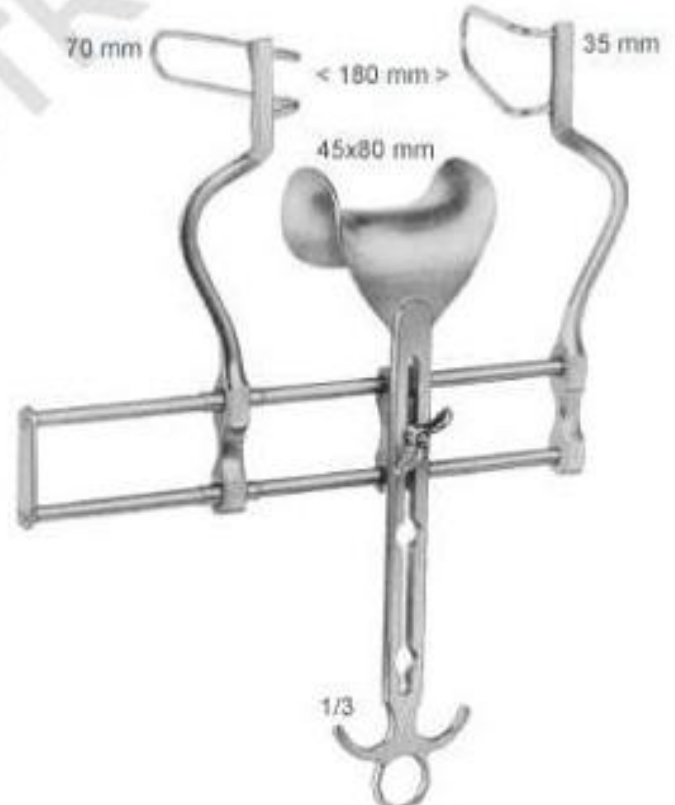

Balfour
47-430



TETRO SURGICAL

Manufacturers & Exporters of Dental, Surgical & Beautycare Instruments.

Abdominal Retractors

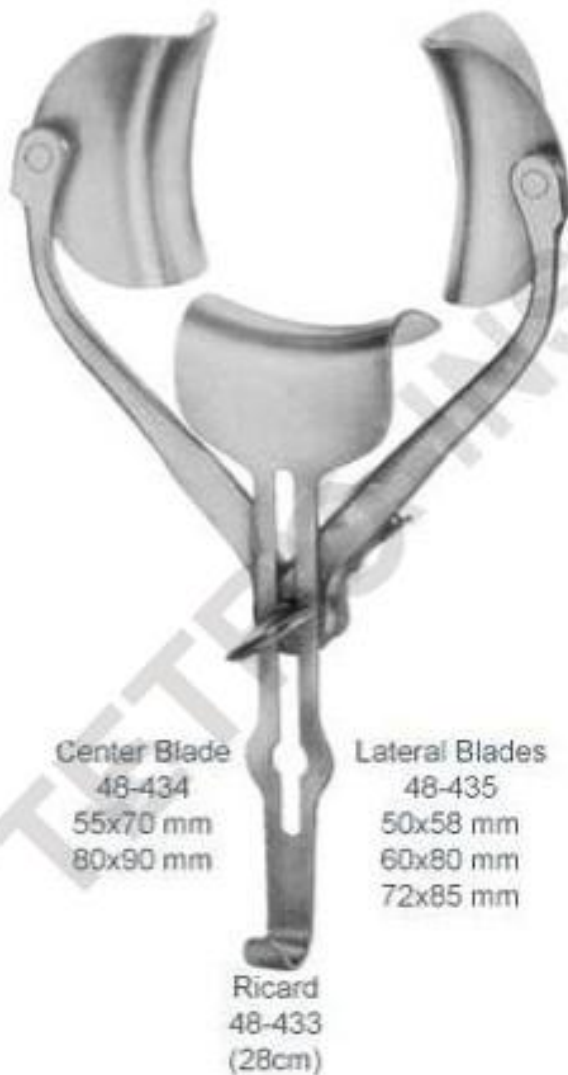
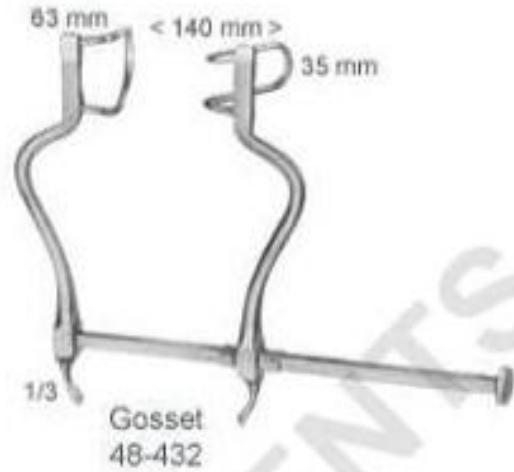
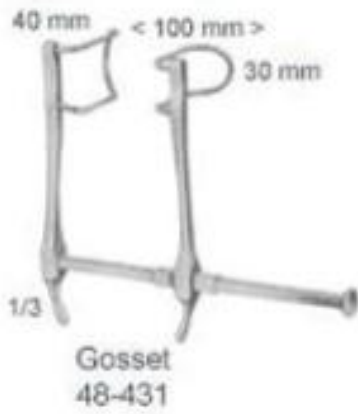



TETRO SURGICAL

Manufacturers & Exporters of Dental, Surgical & Beautycare Instruments.

Suction Tubes, Trocars



Adson
49-437
(21cm)
4 mm



Frazier
(19cm)
49-438 6
49-439 8
49-440 10
49-440/A 12



Ochsner
(14cm)
49-441 (4mm)
49-442 (5.5mm)
49-443 (6.5)



Poole
49-444
(22cm)
10 mm



Poole
49-445
(22cm)
8 mm

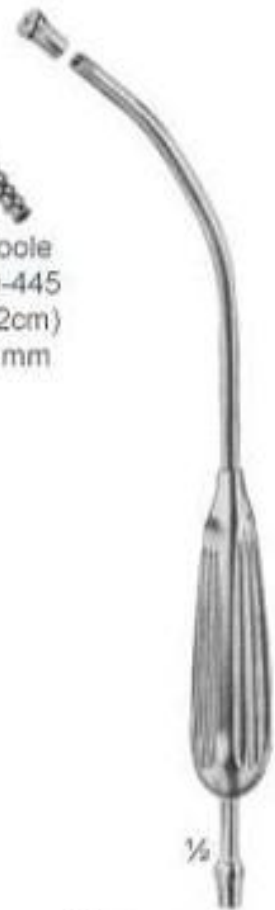

Yankauer
49-450
(27cm)



Fig. 0
49-446



Fig. 1
49-447



Fig. 2
49-448



Fig. 3
49-449



Yankauer
49-446 to 49-449
(27cm)



1/2



TETRO SURGICAL

Manufacturers & Exporters of Dental, Surgical & Beautycare Instruments.

Bone Leavers

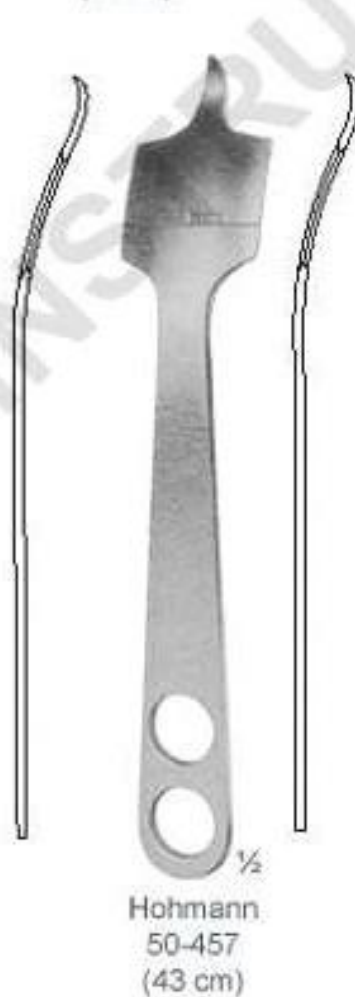



TETRO SURGICAL

Manufacturers & Exporters of Dental, Surgical & Beautycare Instruments.

Bone Holding Forceps

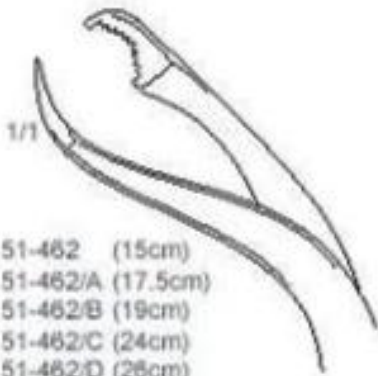

- 51-462 (15cm)
- 51-462/A (17.5cm)
- 51-462/B (19cm)
- 51-462/C (24cm)
- 51-462/D (26cm)
- 51-462/E (28cm)



Verbrugge
51-462



Percy
51-463
(17.5cm)



Lane
51-458
to
51-461

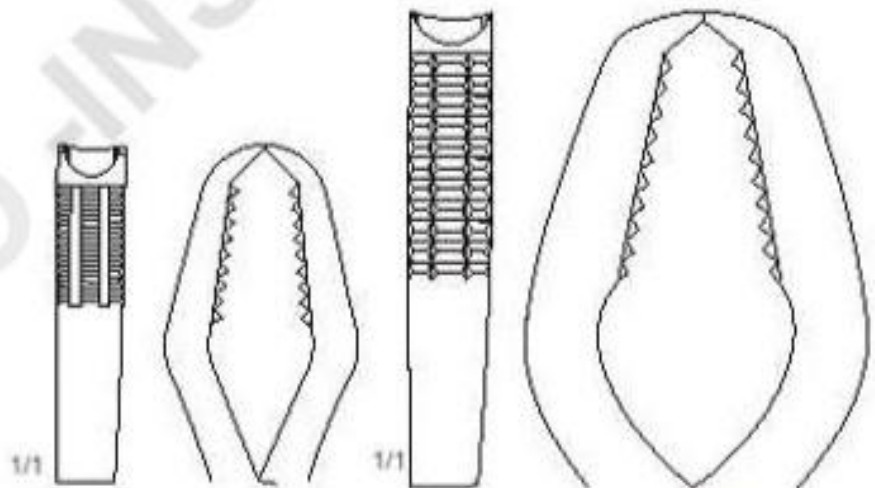

51-458 (33cm)
Without Ratchet
51-459 (33cm)
With Ratchet

51-460 (45cm)
Without Ratchet
51-461 (45cm)
With Ratchet



TETRO SURGICAL

Manufacturers & Exporters of Dental, Surgical & Beautycare Instruments.

Bone Holding Forceps

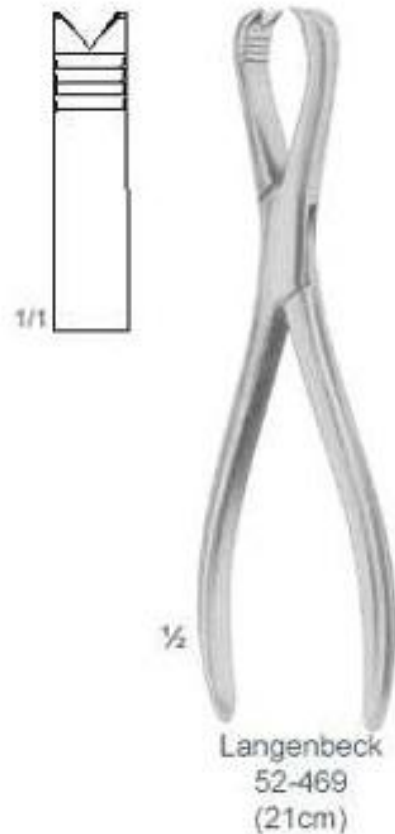
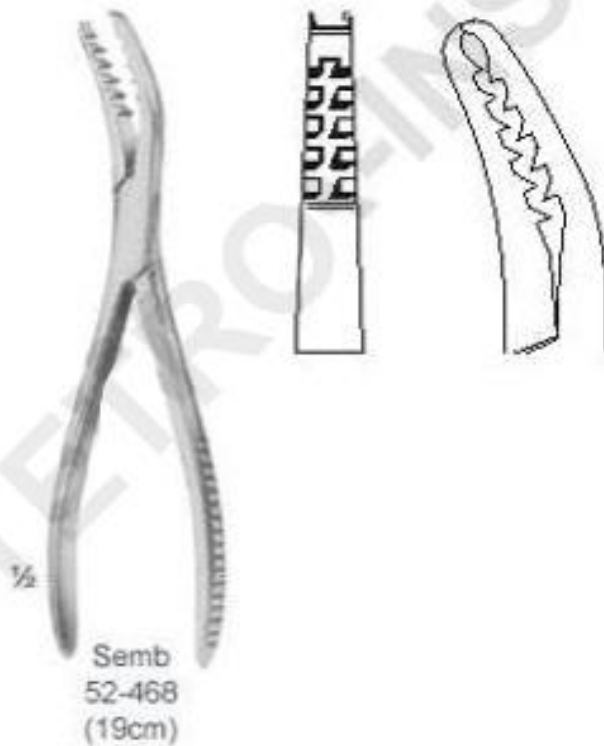
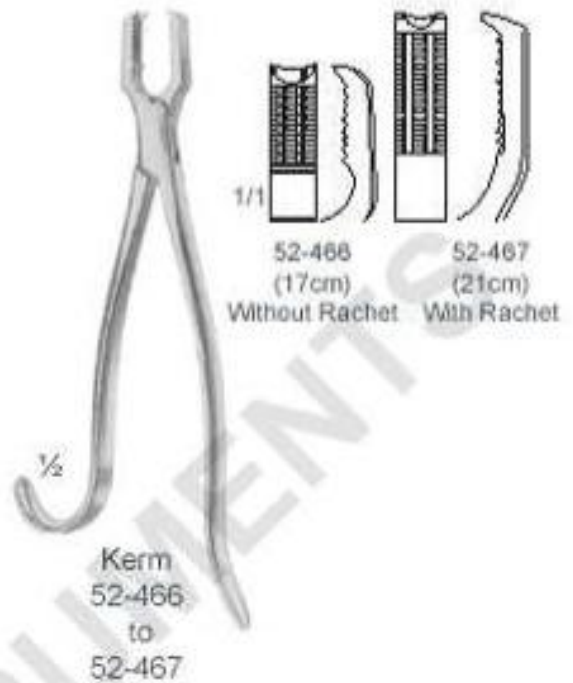
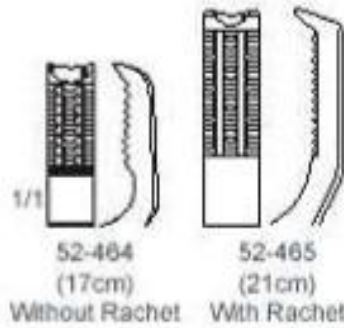



TETRO SURGICAL

Manufacturers & Exporters of Dental, Surgical & Beautycare Instruments.

Bone Cutting Forceps



53-470
(23cm)



53-471
(27cm)



1/2

Liston-Key
53-470 to 53-471



1/2

Stille-Liston
53-472
(27cm)



TETRO SURGICAL

Manufacturers & Exporters of Dental, Surgical & Beautycare Instruments.

Bone Ronger Forceps



Stellbrink
54-473 to 54-474
(17cm)

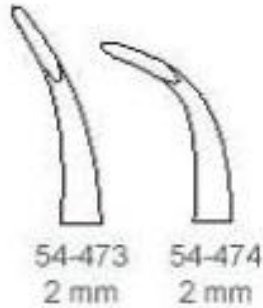

54-473
2 mm 54-474
2 mm

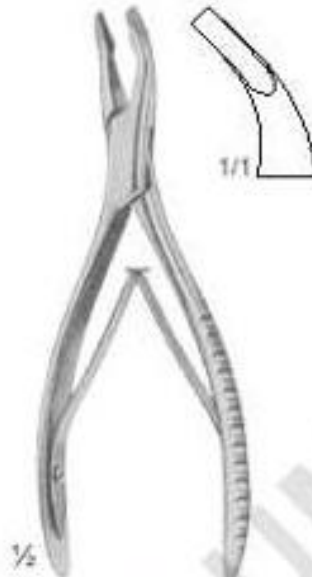

Mead
54-475
(16.5cm)



1/1



Hartmann
54-476
(18.5cm)



1/1



Universal
54-477
(13.5cm)



1/1



Cleveland
54-478
(14cm)



1/1



Mead
54-479
(17cm)



1/1

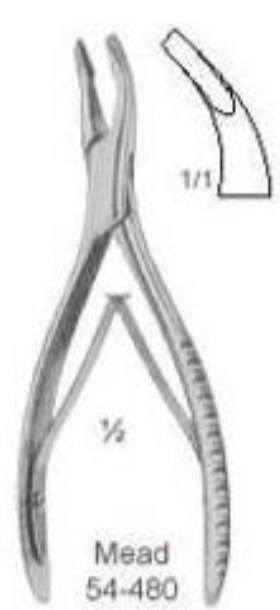

Mead
54-480
(16cm)



1/1



TETRO SURGICAL

Manufacturers & Exporters of Dental, Surgical & Beautycare Instruments.

Bone Ronger Forceps

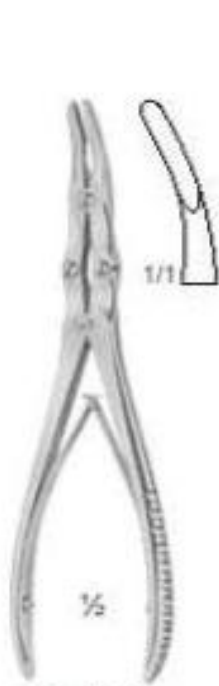

Mayfield
55-481
(17cm)



Marquardt
55-482
(20cm)

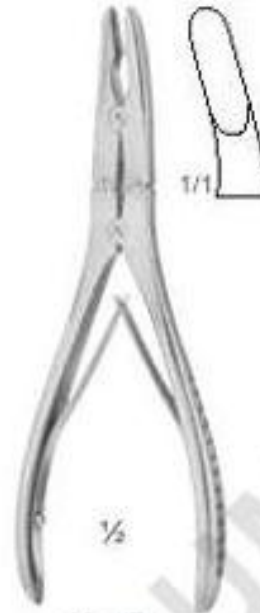

Ruskin
55-483
(18cm)

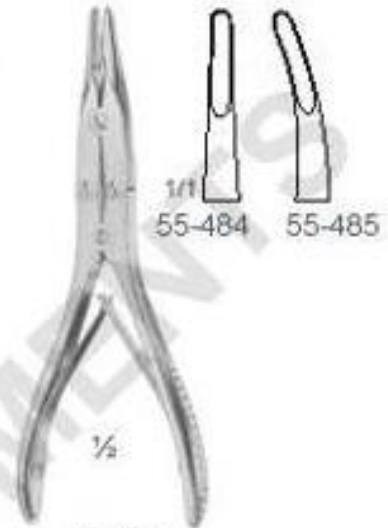

Bohler
55-484
to
55-485



Blumenthal
55-486 to 55-488

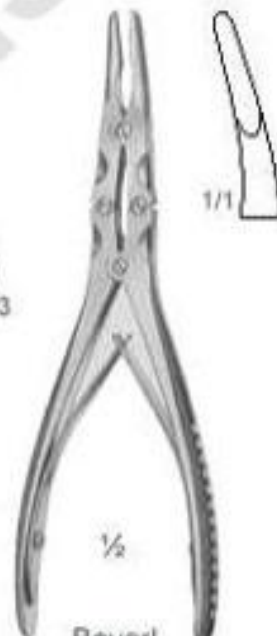

Beyerl
55-489
(18cm)

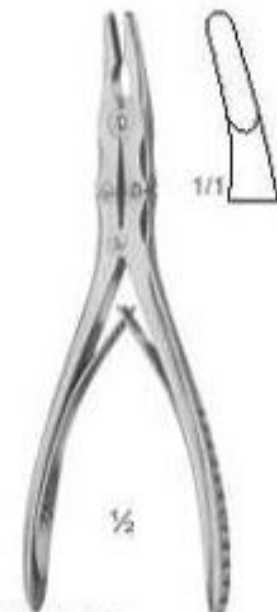

Zaufal-Janseni
55-490
(18cm)



TETRO SURGICAL

Manufacturers & Exporters of Dental, Surgical & Beautycare Instruments.

Vaginal Specula



Cusco
57-497 (75x32 mm)
57-498 (85x35 mm)
57-499 (100x37 mm)



Cusco
57-506
(S.M.L.)



Pederson
57-500 (75x13 mm)
57-501 (100x22 mm)
57-502 (120x25 mm)



Sakuras
57-507
(S.M.L.)



Collin
57-503 (85x30 mm)
57-504 (100x35 mm)
57-505 (110x40 mm)



Grave
57-508 (75x20 mm)
57-509 (95x35 mm)
57-510 (115x35 mm)



TETRO SURGICAL

Manufacturers & Exporters of Dental, Surgical & Beautycare Instruments.

Vaginal Specula



Cusco
57-497 (75x32 mm)
57-498 (85x35 mm)
57-499 (100x37 mm)



Cusco
57-506
(S.M.L.)



Pederson
57-500 (75x13 mm)
57-501 (100x22 mm)
57-502 (120x25 mm)



Sakuras
57-507
(S.M.L.)



Collin
57-503 (85x30 mm)
57-504 (100x35 mm)
57-505 (110x40 mm)



Grave
57-508 (75x20 mm)
57-509 (95x35 mm)
57-510 (115x35 mm)



Vaginal Specula

58-511 (65x25 mm)
(70x30 mm)
58-512 (70x30 mm)
(70x35 mm)
58-513 (85x35 mm)
(90x40 mm)

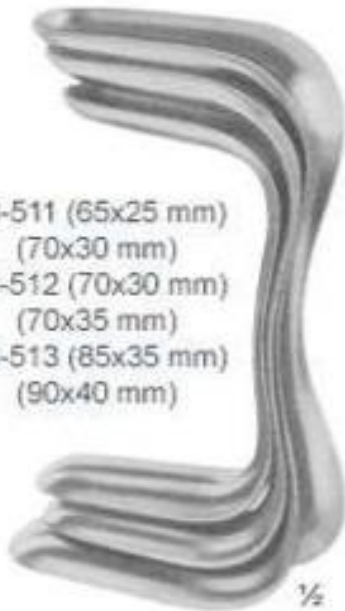

Kristeller

Fig. 1 58-514 (70x27 mm)
Fig. 2 58-515 (80x30 mm)
Fig. 3 58-516 (90x36 mm)



Kristeller

Fig. 1 58-517 (75x23 mm)
Fig. 2 58-518 (85x26 mm)
Fig. 3 58-519 (100x32 mm)

Semm
58-520 (100x17/20 mm)
58-521 (100x25/30 mm)



Jackson
58-522 (75x35 mm)
58-523 (90x35 mm)
58-524 (100x35 mm)
58-525 (75x40 mm)
58-526 (90x40 mm)
58-527 (100x40 mm)



Kristeller
Fig. 1 58-528
Fig. 2 58-529
Fig. 3 58-530





TETRO SURGICAL

Manufacturers & Exporters of Dental, Surgical & Beautycare Instruments.

Anal Retractors, Rectal Specula Sphincteroscope Anoscope, Proctoscopes



1/2

Kelly

59-531 (21 mm O x 50 mm)

59-532 (27 mm O x 50 mm)



1/2

Kelly

59-533 (22 mm O x 50 mm)

59-534 (22 mm O x 100 mm)

59-535 (22 mm O x 140 mm)



1/2

Newman

59-536 (16 mm O x 63 mm)

59-537 (19 mm O x 63 mm)

59-538 (23 mm O x 63 mm)



1/2

Mathieu

59-539

(19.5 cm)



1/2

Hirschmann

59-540 (16 mm O x 65 mm)

59-541 (19 mm O x 65 mm)

59-542 (23 mm O x 65 mm)



1/2

Barr

59-543

(17 cm)



TETRO SURGICAL

Manufacturers & Exporters of Dental, Surgical & Beautycare Instruments.

Uterine Sounds & Depressors



Sims
60-544 (32cm)
60-545 (32cm)



Sims
60-546 (32cm)
60-547 (32cm)



Valleix
60-548
(25cm)



Braun
60-549
(28cm)



Uterine Probe
60-550



TETRO SURGICAL

Manufacturers & Exporters of Dental, Surgical & Beautycare Instruments.

Uterine Dilators



61-551
Set of 8 Dilators
3.0 mm O
4.0 mm O
17.0 mm O
18.0 mm O



Hegar
61-552
Set of 8 Dilators
3.0 mm O
4.0 mm O
17.0 mm O
18.0 mm O



Hegar
61-553
Set of 13 Dilators
1.0 mm O
2.0 mm O
25.0 mm O
26.0 mm O



TETRO SURGICAL

Manufacturers & Exporters of Dental, Surgical & Beautycare Instruments.

Antrum Punch Forceps Sphenoid Punches

4x4 mm 5x5 mm 6x6 mm
62-556 (4 mm) 62-557 (5 mm) 62-558 (6 mm)



1/2

Hajek-Claus
62-555
(20cm)



90 mm / 3 1/2"

1/2

Kerrison
62-556 to 62-558
(20cm)



TETRO SURGICAL

Manufacturers & Exporters of Dental, Surgical & Beautycare Instruments.

Punches and Curetts

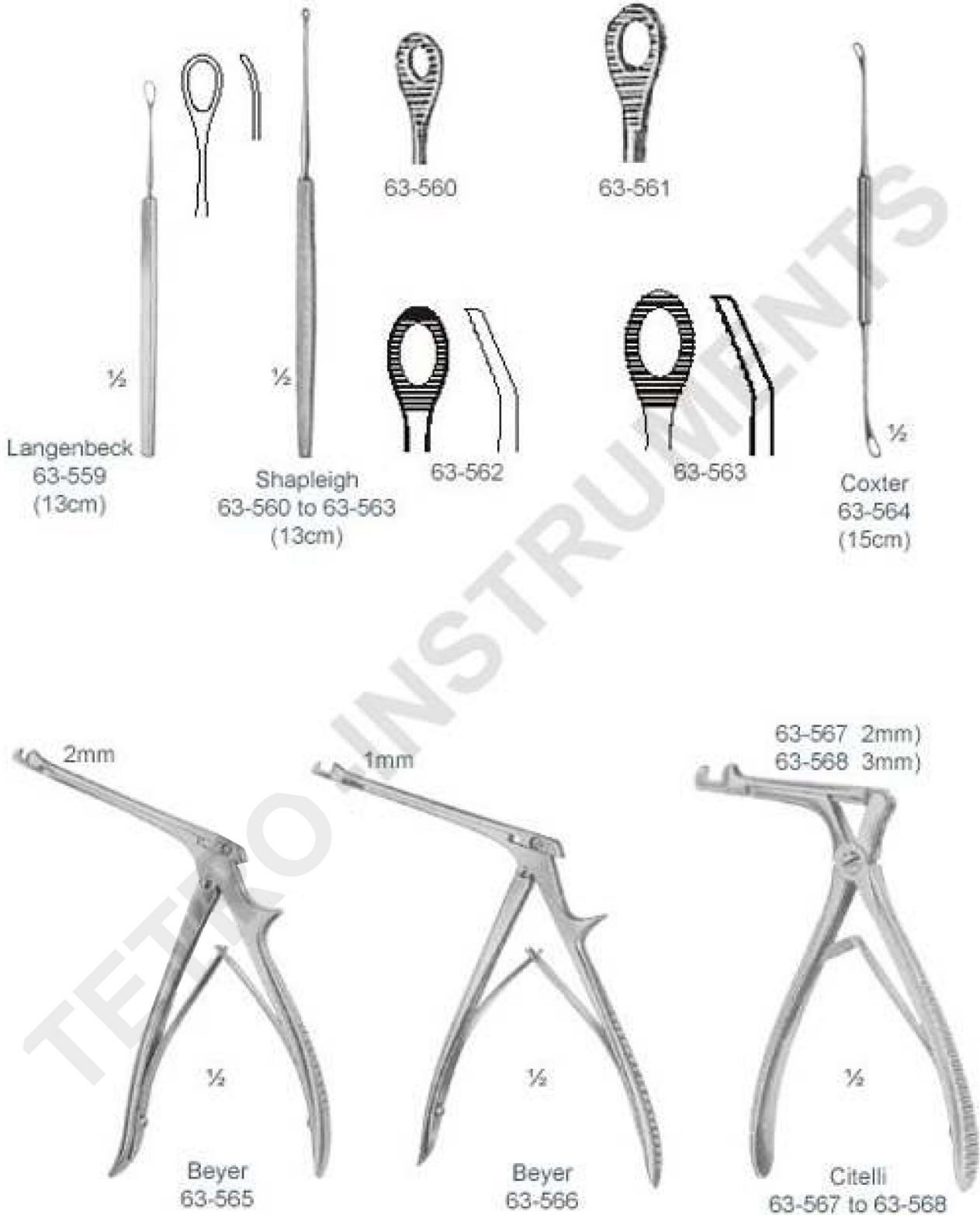



TETRO SURGICAL

Manufacturers & Exporters of Dental, Surgical & Beautycare Instruments.

Septum Compression Forceps



Middleton-Jansen
64-569
(19cm)



Middleton-Jansen
64-570
(19cm)



Jansen-Struycken
64-571
(19cm)



TETRO SURGICAL

Manufacturers & Exporters of Dental, Surgical & Beautycare Instruments.

Cervical Biopsy & Specimen Forceps



Shaft
65-572
(18cm)

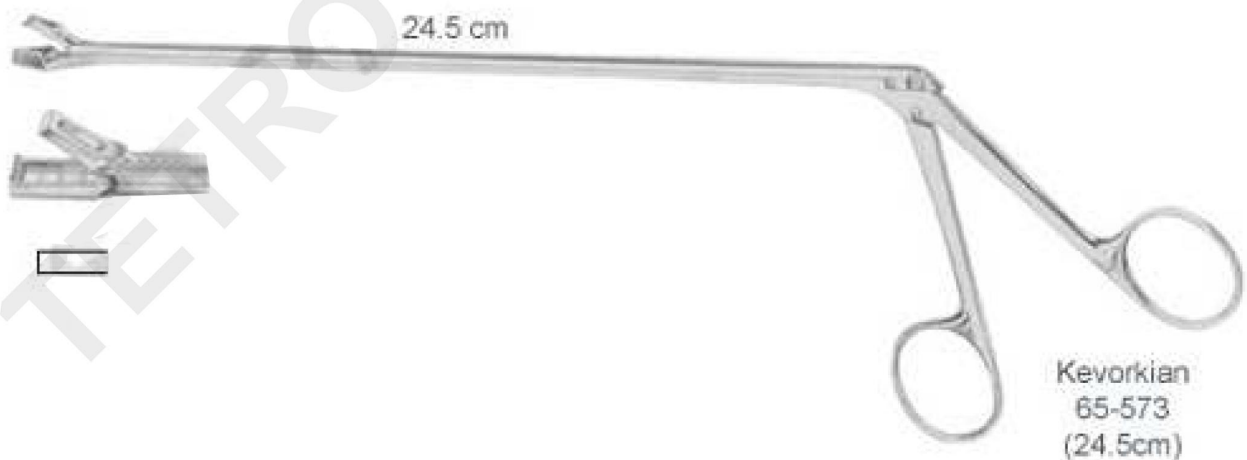



TETRO SURGICAL

Manufacturers & Exporters of Dental, Surgical & Beautycare Instruments.

Nasal Specula



Mod-Wien
66-574
(14.5cm)



Killian
66-575
to
66-578
(13cm)

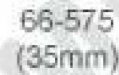
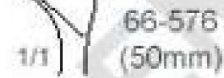
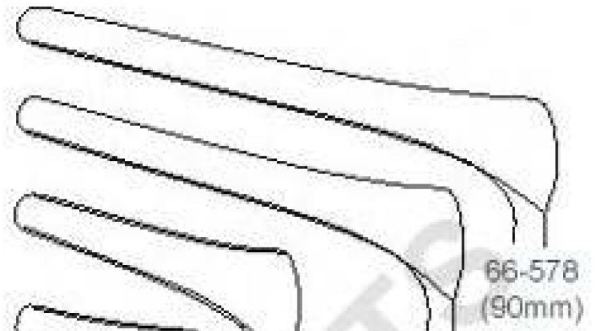

66-579
(13cm)



Tieck-halle
66-580
(13.5cm)



66-581
(13cm)



Tieck-Halle
66-582
(13.5cm)



TETRO SURGICAL

Manufacturers & Exporters of Dental, Surgical & Beautycare Instruments.

Ear Dressing & Ear Polypus Forceps



Krause
67-583
(16cm)



Krause-Voss
67-584
(16cm)



10 mm/33ft

67-585
(0.3 mm o)

67-586
(0.4 mm o)

Steel Wire For Ear Snare



67-587
(0.2 mm o)



Troeltsch (Wilde)
67-588
(11cm)

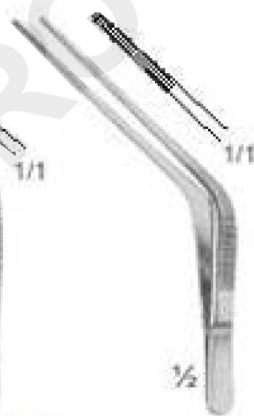

Troeltsch (Wilde)
67-589
(12cm)



Troeltsch (Wilde)
67-590
(13cm)



Lucae
67-591
(14cm)



Jansen
67-592 (16cm)
67-593 (20cm)



TETRO SURGICAL

Manufacturers & Exporters of Dental, Surgical & Beautycare Instruments.

Ear Dressing & Ear Polypus Forceps



Hartmann-Wullstein
68-594
(8.5cm)



Hartmann-Wullstein
68-595
(8.5cm)



Hartmann
68-596 (8.5cm)
68-597 (14cm)
68-598 (16.5cm)



Hartmann
68-599 (8.5cm)



Hartmann-Noyes
68-600
(9cm)



Hartmann-Noyes
68-601
(9cm)



Hartmann-Weingartner
68-602
(8.5cm)



Hartmann
68-603
(8.5cm)

- 2 mm
- 2.5 mm
- 3 mm



Hartmann
68-604 (2 mmO)
68-605 (2.5 mmO)
68-606 (3 mmO)

○ 3 mm



Hartmann
68-607
(8.5cm)



Struempel
68-608
(8.5cm)

○ 2 mm



Hartmann-Hoffmann
68-609
(8.5cm)



68-594 to 68-609



TETRO SURGICAL

Manufacturers & Exporters of Dental, Surgical & Beautycare Instruments.

Tongue Depressors, Cheek & Lip Retractors



Andrew
69-610
(11cm)

1/2



Hartmann
69-611
(15cm)

1/2

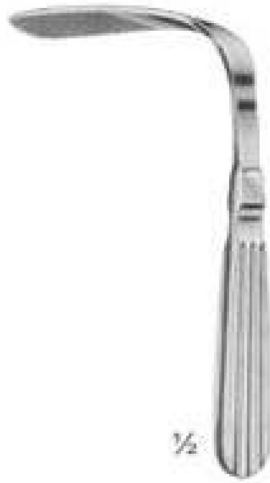

Tobold
69-612
(14.5cm)

1/2

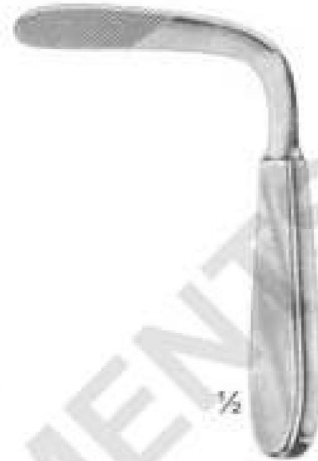

Tobold
69-613
(14.5cm)

1/2



Wieder
69-614 to 69-615

1/2



69-614
(14cm)



69-615
(15cm)



Sternberg
69-616 (12cm)
69-617 (14cm)
69-618 (16cm)



Sternberg
69-619 (14cm)
69-620 (16cm)
69-621 (18cm)

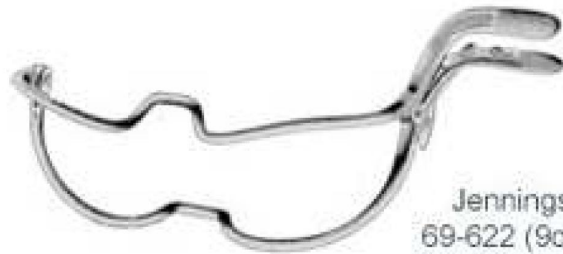

Jennings
69-622 (9cm)
69-623 (11cm)
69-624 (13cm)
69-625 (15cm)



TETRO SURGICAL

Manufacturers & Exporters of Dental, Surgical & Beautycare Instruments.

Mouth Gags



½

Denhart
70-626
(12cm)



Roser-Konig
70-627 (16cm)
70-628 (20cm)



½

Heister
70-629
(13cm)

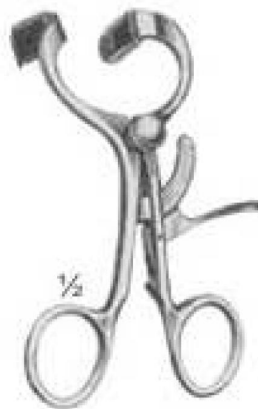

½

Molt
70-630
(11cm)

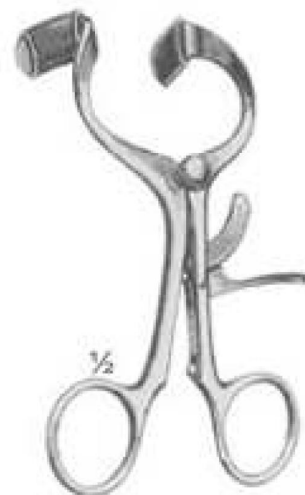

½

Molt
70-631
(14cm)



TETRO SURGICAL

Manufacturers & Exporters of Dental, Surgical & Beautycare Instruments.

Tonsil Snares

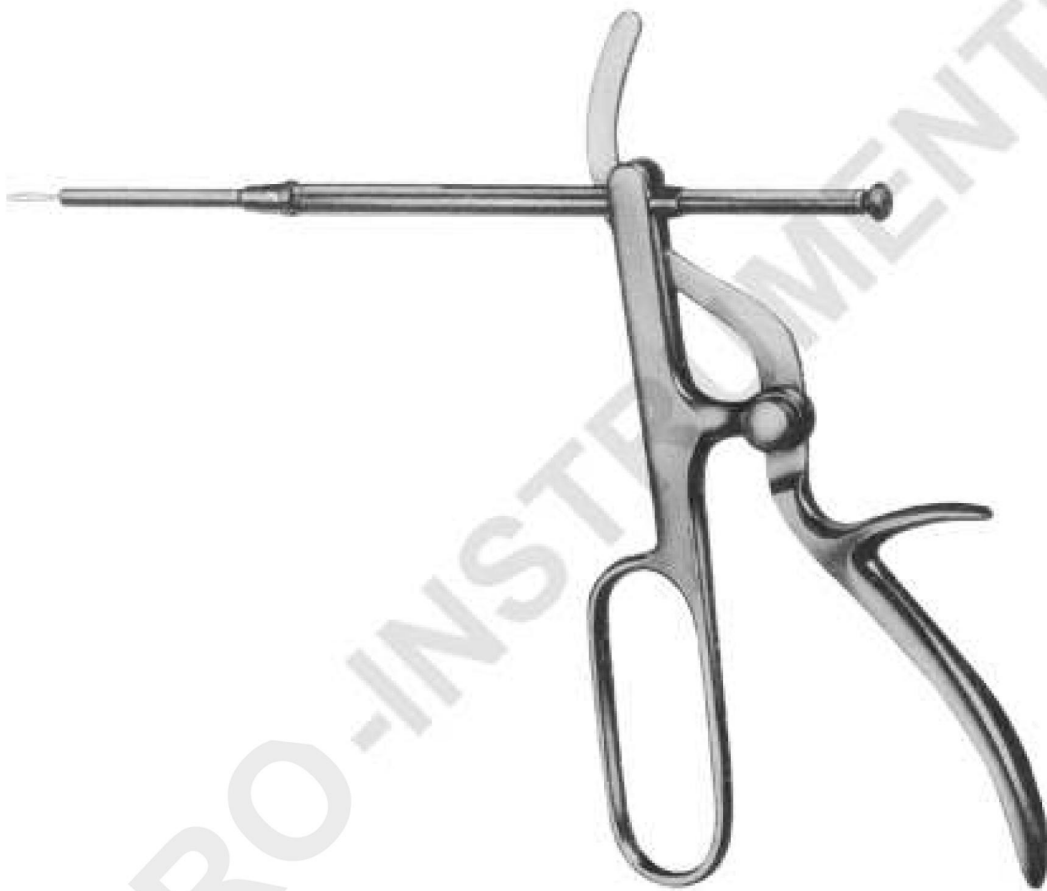

Tyding
71-632
With 1 Straight Tip



TETRO SURGICAL

Manufacturers & Exporters of Dental, Surgical & Beautycare Instruments.

Tongue Holding Forceps



72-635

Young
72-634
(17cm)

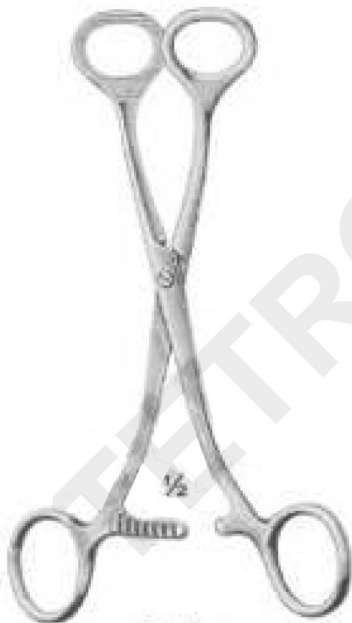

Collin
72-633
(17cm)



Guy
72-636
(19cm)



TETRO SURGICAL

Manufacturers & Exporters of Dental, Surgical & Beautycare Instruments.

Sterilizing Forceps





TETRO SURGICAL

Manufacturers & Exporters of Dental, Surgical & Beautycare Instruments.

Laryngeal Polypus Forceps



Chevalier-Jackson
74-641 to 74-668
(23cm)



Cm Inch

30	12	74-641	74-645	74-649	74-653	74-657	74-661	74-665
40	16	74-642	74-646	74-650	74-654	74-658	74-662	74-666
50	20	74-643	74-647	74-651	74-655	74-659	74-663	74-667
60	24	74-644	74-648	74-652	74-656	74-660	74-664	74-668



7



74-670



74-671



74-672



Jurasz
74-669 to 74-672
(23cm)



TETRO SURGICAL

Manufacturers & Exporters of Dental, Surgical & Beautycare Instruments.

Rhino Plastic Instruments



75-673



75-674



75-675

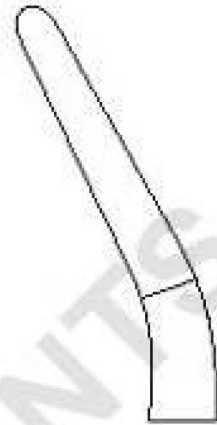

½

Cottle-Walsham
75-673 to 75-675
(23cm)



½

Kressner
75-676
(20cm)



½

Asch
75-677
(23cm)



TETRO SURGICAL

Manufacturers & Exporters of Dental, Surgical & Beautycare Instruments.

Rhino Plastic Instruments





TETRO SURGICAL

Manufacturers & Exporters of Dental, Surgical & Beautycare Instruments.

Rhino Plastic Instruments



Joseph
77-687
(15cm)



Cottle
77-688
(16cm)



Lange
77-689
(22cm)



Fommon
77-690 to
77-692
(15cm)



77-690



77-691



77-692



Kilner
77-693
(10cm)



Converse
77-694
(12cm)



Freer
77-695
(15cm)



Fommon
77-696
(17cm)



Aufrecht
77-697
(19cm)





TETRO SURGICAL

Manufacturers & Exporters of Dental, Surgical & Beautycare Instruments.

Hollow Wears



78-698
STERILIZING DRUM



78-699
ELECTRIC STERILIZING



78-700
HORIZONTAL URINAL



78-701
URINAL FEMALE

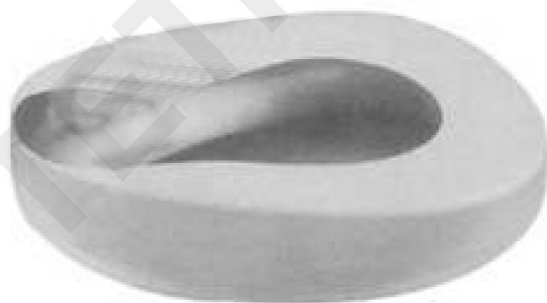

78-702
PERFECTION BEDPAN



78-703
URINAL MALE



TETRO SURGICAL

Manufacturers & Exporters of Dental, Surgical & Beautycare Instruments.

Hollow Wears



79-704
KIDNEY TRAY



79-706
THERMOMETER JAR



79-707
FEEDING CUP



79-708
DOUCHE CAN / IRRIGATOR



79-709
MEASURING JUG



79-710
ALCOHAL LAMP



79-711
SPUTUM MUG



79-712
WASH BASIN



TETRO SURGICAL

Manufacturers & Exporters of Dental, Surgical & Beautycare Instruments.

Hollow Wears

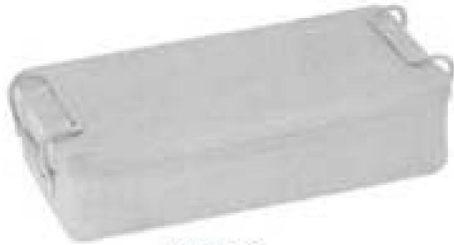

80-713
BOX WITH LOCK



80-714
MESH TRAY



80-715
INSTRUMENTS BOX

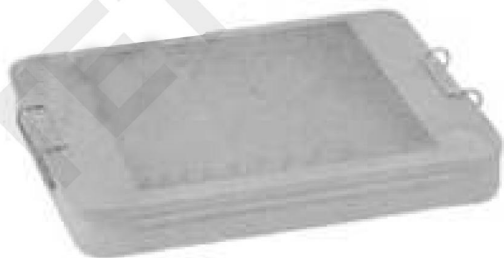

80-716
STERILIZER BOX WITH FILTER



80-717
INSTRUMENTS STERILIZING BOX

SURGICAL



TETRO SURGICAL

Manufacturers & Exporters of Dental, Surgical & Beautycare Instruments.

+92 305 823 6257

✉ info@tetrosurgical.com 🌐 www.tetrosurgical.com

📍 Mohallah Muzaffar pur, Defence Road, Sialkot-Pakistan