

DENTAL

INSTRUMENTS CATALOGUE



TETRO SURGICAL

Manufacturers & Exporters of Dental, Surgical & Beautycare Instruments.

+92 305 823 6257

✉ info@tetrosurgical.com 🌐 www.tetrosurgical.com

📍 Mohallah Muzaffar pur, Defence Road, Sialkot-Pakistan



Extracting Forceps

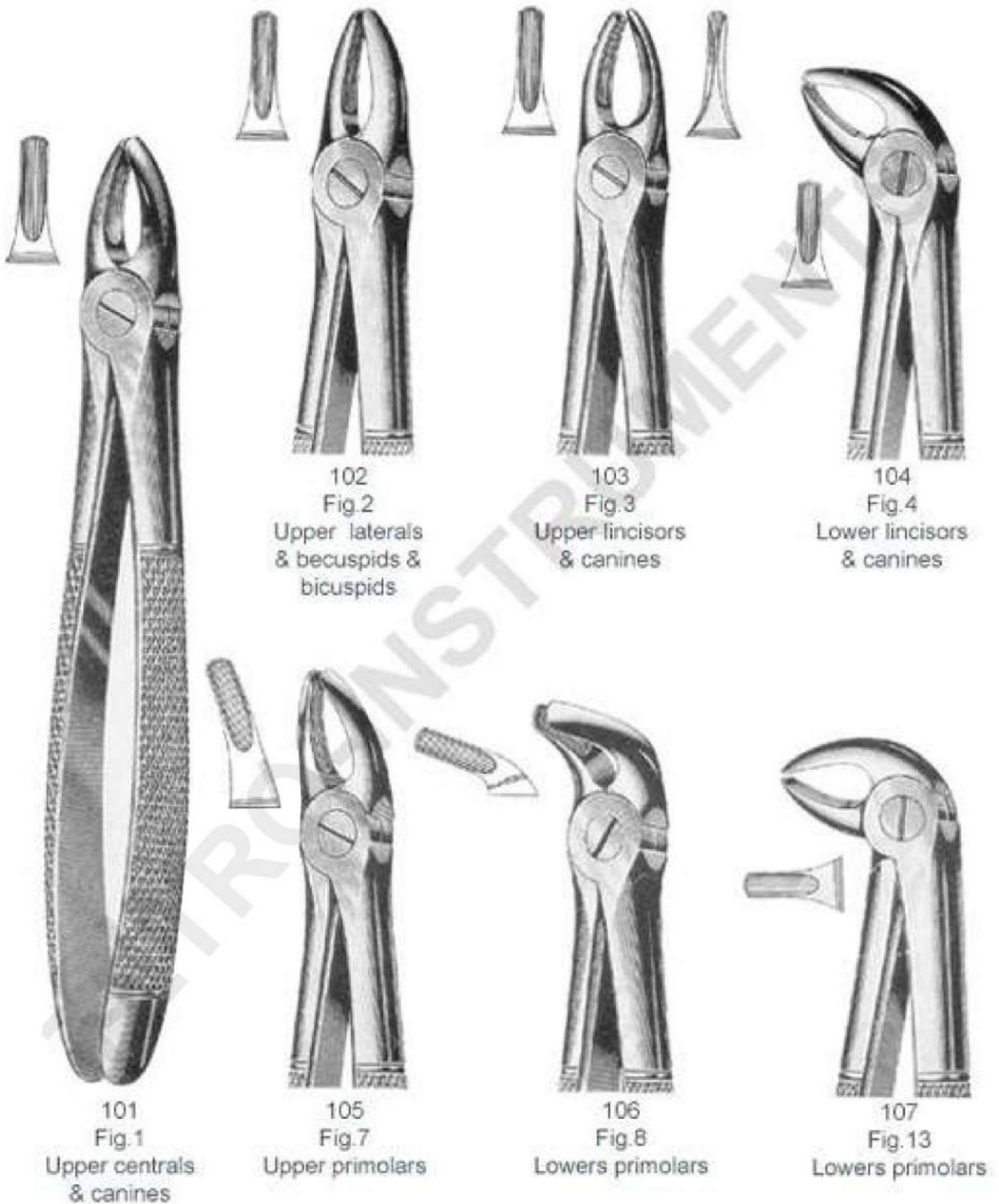



TETRO SURGICAL

Manufacturers & Exporters of Dental, Surgical & Beautycare Instruments.

Extracting Forceps





Extracting Forceps



115
Fig. 23
Right upper molars



116
Fig. 24
Left lower molars



117
Fig. 29
Upper root & incisors



118
Fig. 29N
Roots of upper incisors



119
Fig. 30
Upper root & incisors



120
Fig. 31
Lower roots



121
Fig. 32
Lower molars



Extracting Forceps



130
Fig.51A
Upper roots narrow
beak

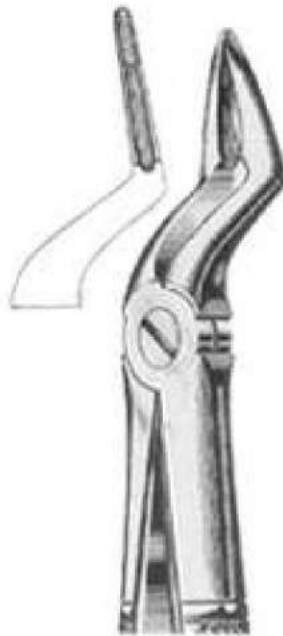

131
Fig.51C
Upper roots

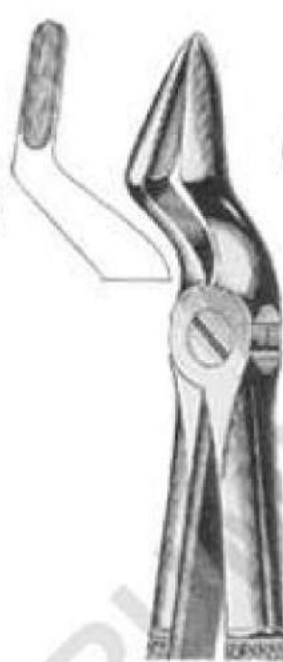

132
Fig.52
Upper roots & canines
with wider beak



133
Fig.52A
Upper roots &
resection



134
Fig.55
Separating upper
molars roots



135
Fig.56
Separating lower
molars roots



136
Fig.67
Upper wisdoms

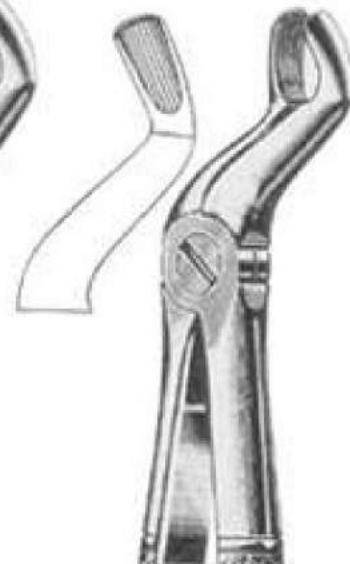

137
Fig.67A
Upper wisdoms



Extracting Forceps



138
Fig.68
Lower roots



Fig.73
Lower molars (hawk's bill)



140
Fig.74
Lower incisors
& roots



141
Fig.74M
Lower incisors
& roots



142
Fig.74N
Lower incisors & roots

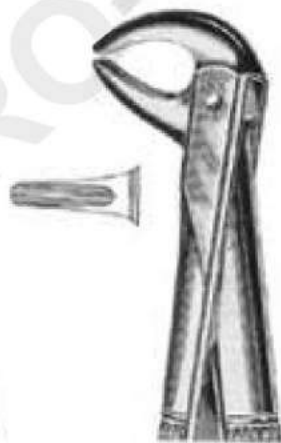

143
Fig.75
Lower premolars
& canines



144
Fig.76
Upper roots



145
Fig.76M
Upper roots
Narrow break



Extracting Forceps



146
Fig.79
Lower wisdoms



147
Fig.79A
Lower wisdoms



148
Fig.86A
Lower molars



149
Fig.86B
Lower molars



150
Fig.86C
Lower molars



151
Fig.87
Cowhorn beak



152
Fig.89
Right upper molars



153
Fig.9
Left upper molars



Extracting Forceps

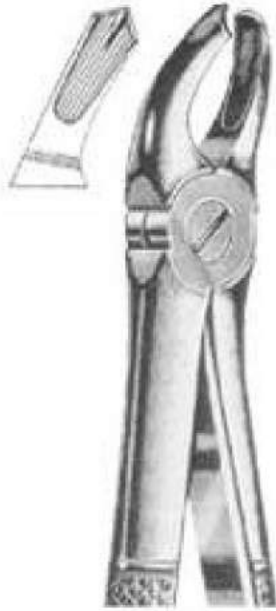

154
Fig.94
Right upper molars



155
Fig.95
Left upper molars



156
Fig.99
Lower molars
(brpken-down)



157
Fig.99 1/4
Lower molars
(brpken-down)



158
Fig.121
Upper wisdoms



159
Fig.136
Upper centrals & roots

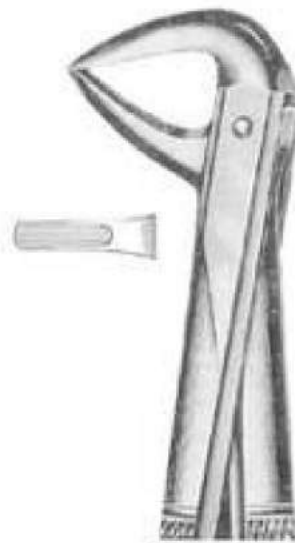

160
Fig.137
Lower centrals
& roots

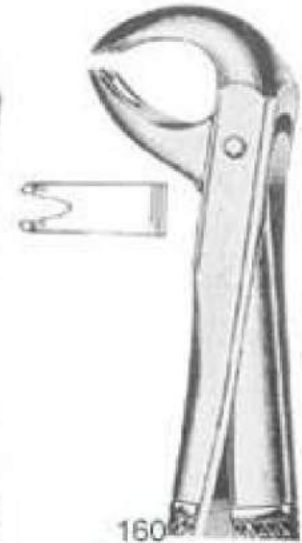

160
Fig.137
Universal pattrer for
lower teeth molars
& premolars



Extracting Forceps



162
Fig.168
Upper canines

163
Fig.169
Lower canines
& premolars

164
Fig.233
Lower roots
(parallel beaks)

165
Fig.235
Lower roots
(parallel beaks)



166
Fig.MD 1
Universal Forceps
for upper wisdoms
premolars & roots

167
Fig.MD 2
Upper molars

168
Fig.MD 3
Lower incisors,
premolars & roots

169
Fig.MD 4
Lower molars



Extracting Forceps

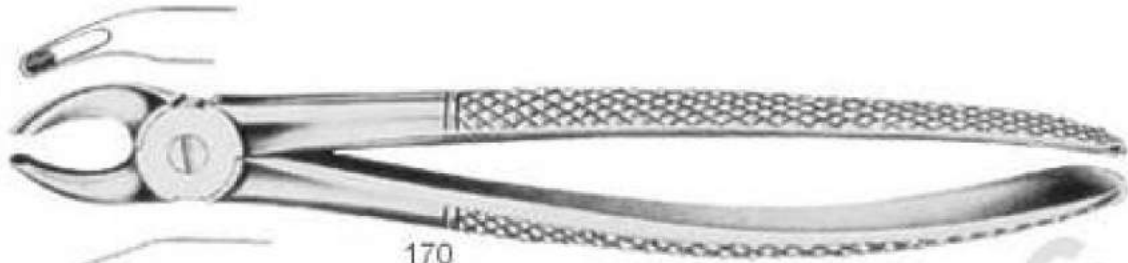

170
Fig. 158

Children, s upper teeth molars universal

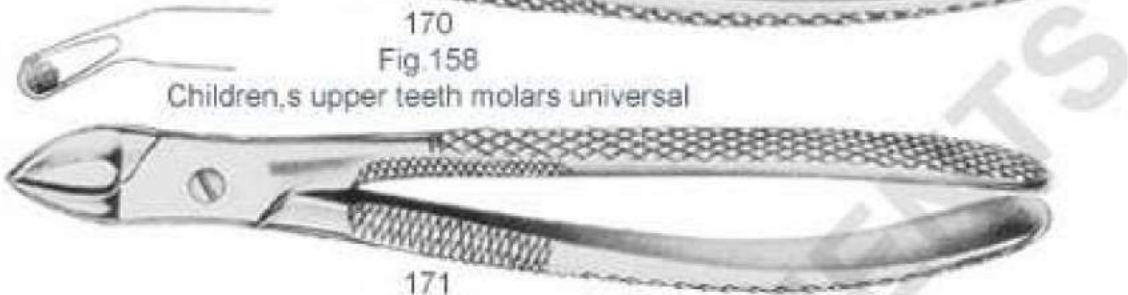

171
Fig. 159

Children, s lower molars universal



172
Fig. 160

Children, s upper lower universal (hawk's bill)

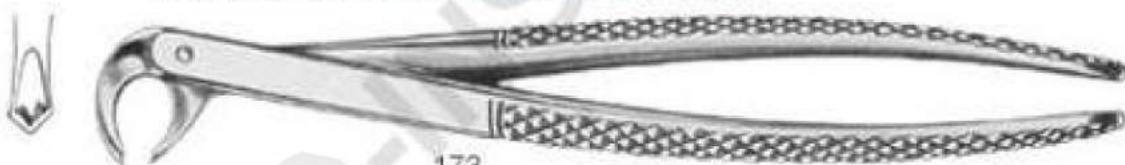

173
Fig. 161

Children, s lower & roots

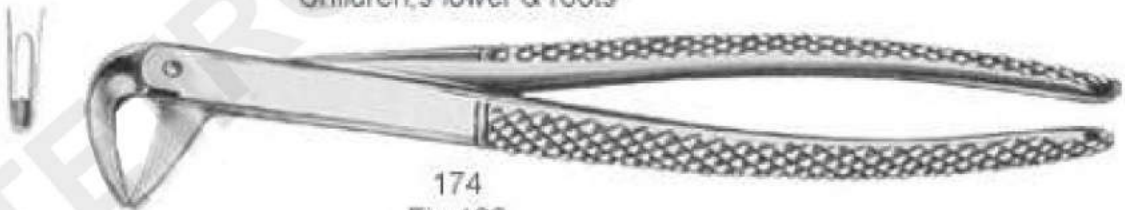

174
Fig. 162

Children, s upper centrals



175
Fig. 163

Children, s upper centrals



TETRO SURGICAL

Manufacturers & Exporters of Dental, Surgical & Beautycare Instruments.

Extracting Forceps

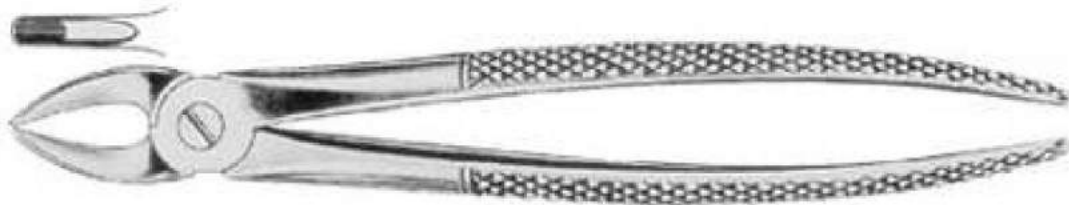

176

Fig.137

Children,s upper incisors & canines

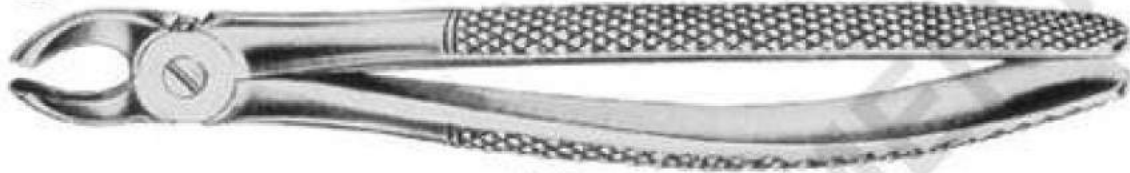

177

Fig.139

Children,s upper molars & universal

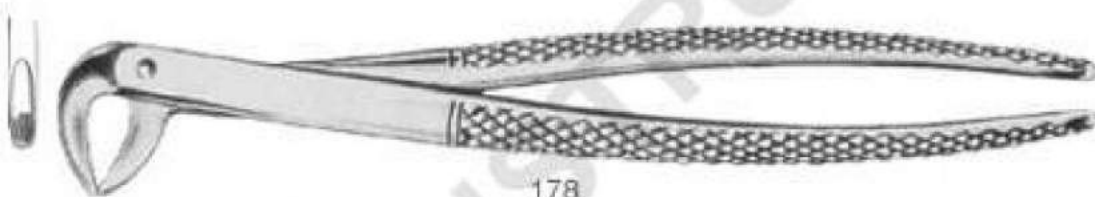

178

Fig.123

Children,s lower teeth universal

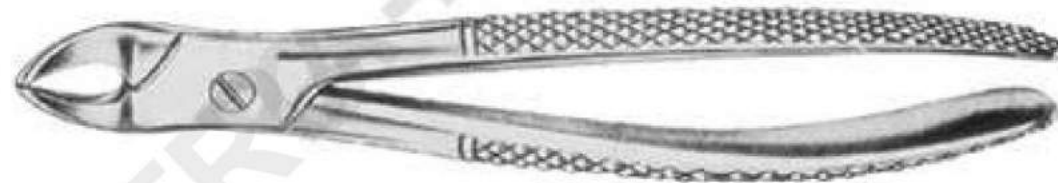
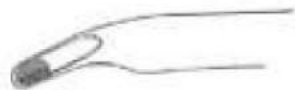

179

Fig.138

Children,s upper universal & roots

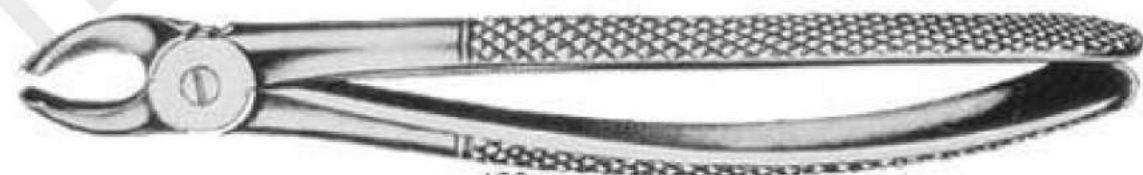

180

Fig.157

Children,s upper molars universal



TETRO SURGICAL

Manufacturers & Exporters of Dental, Surgical & Beautycare Instruments.

Extracting Forceps



181
Universal pattern for
upper teeth

182
Universal pattern for
lower teeth

183
Left lower wisdoms
& molars

184
Right lower wisdoms
& molars



Wisdom Teeth Extracting Forceps



185
Fig. 3
Upper molars

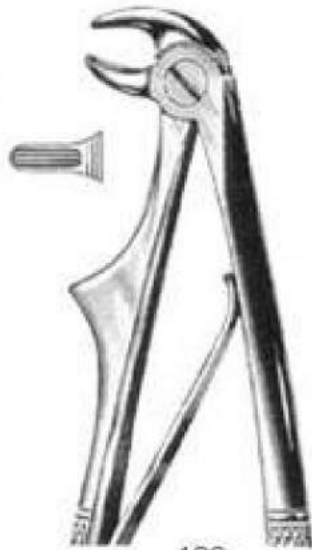

186
Fig. 3
Lower incisors

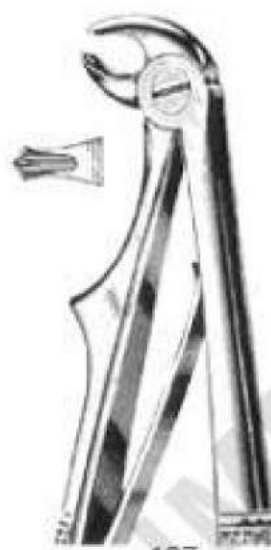

187
Fig. 5
Lower molars



188
Fig. 7
Lower roots



189
Fig. 137
Upper incisors & canines



190
Fig. 139
Upper premolars



191
Fig. 51S
Upper roots



Tooth Extracting Forceps



192
Fig.1
Upper centrals, laterals
& cuspids

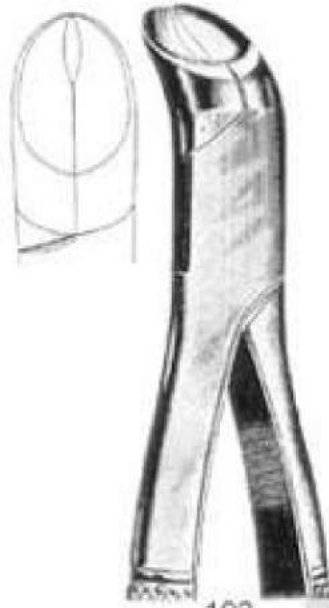

193
Fig.5
Lower third molars

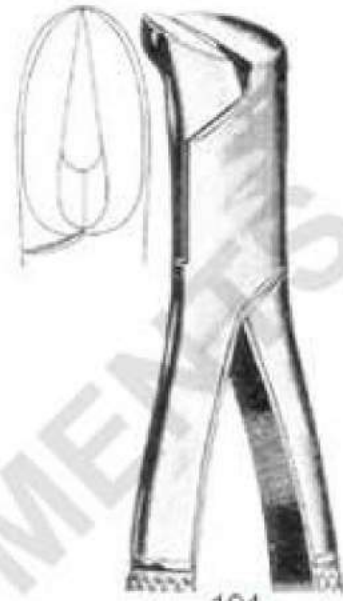

194
Fig.6
Splitting forceps



195
Fig.10H
Upper molars hook-handle



196
Fig.10 S
Upper molars
hook-handle

197
Fig.15
Lower molars



Tooth Extracting Forceps

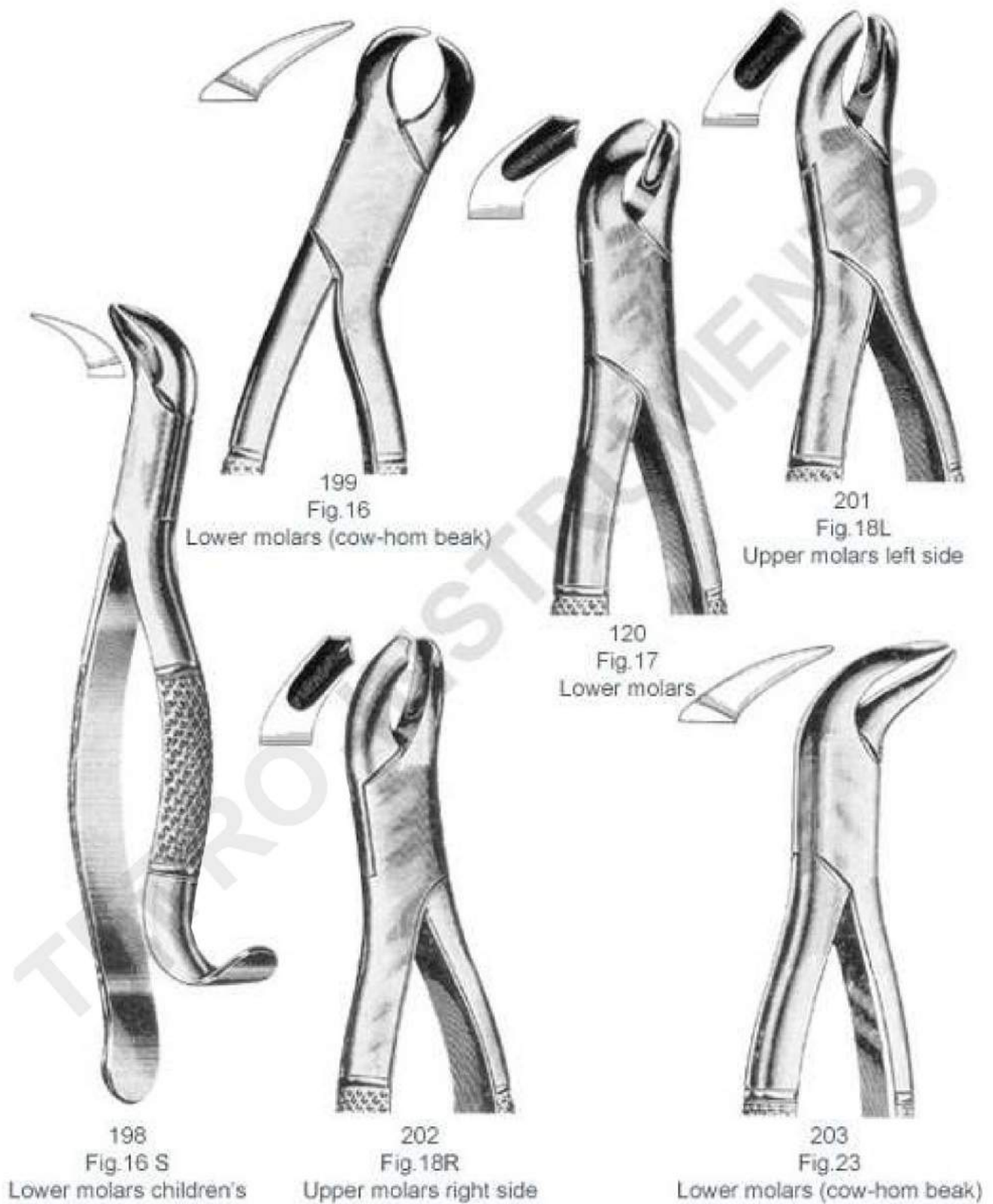



Tooth Extracting Forceps



204
Fig.32

Upper molars & pre
molars strong beak



205
Fig.53 L

Upper molars left side



206
Fig.53 R

Upper molars right side



207
Fig.62

Universal forceps for upper
teeth & roots

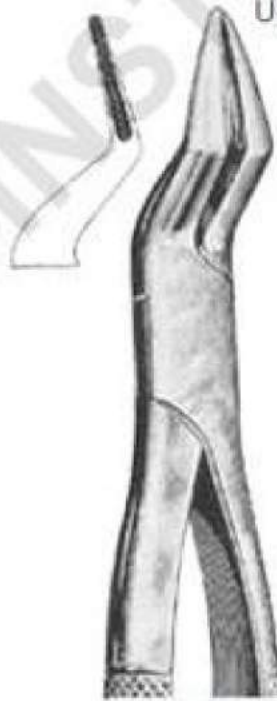

208
Fig.65

Upper incisors
& root



209
Fig.69

Fragments & small roots
upper & lower



Tooth Extracting Forceps

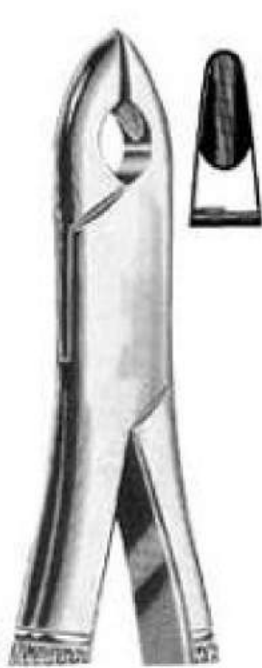

210
Fig. 88 R
Right upper molars



211
Fig. 88 L
Left upper molars



212
Fig. 99C
Upper molars Molar
& incisors



213
Fig. 101
Universal forceps for
permolars

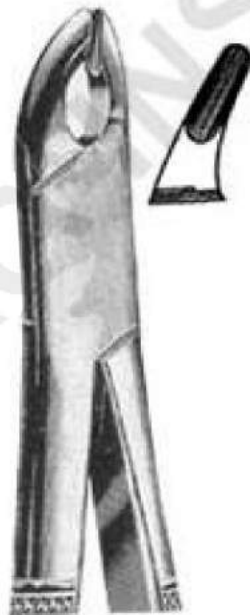

214
Fig. 150
Upper premolars incisprs
& roots

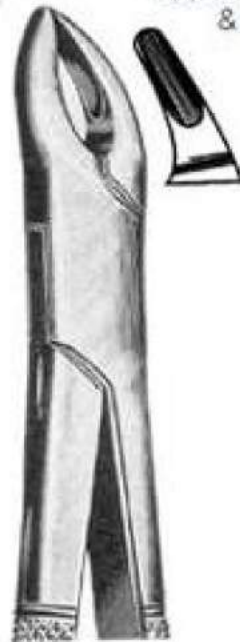

215
Fig. 150A
Upper premolars
& roots



216
Fig. 150S
Upper premolars
incisprs & roots for children



Tooth Extracting Forceps

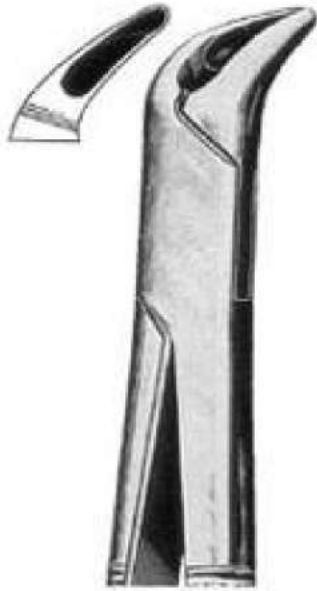

217

Fig.151

Lower premolars incisors & roots

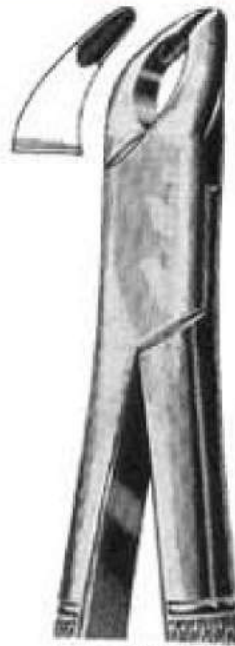

218

Fig.151A

Lower premolars incisors & roots



219

Fig.151S

Lower premolars incisors & roots for children

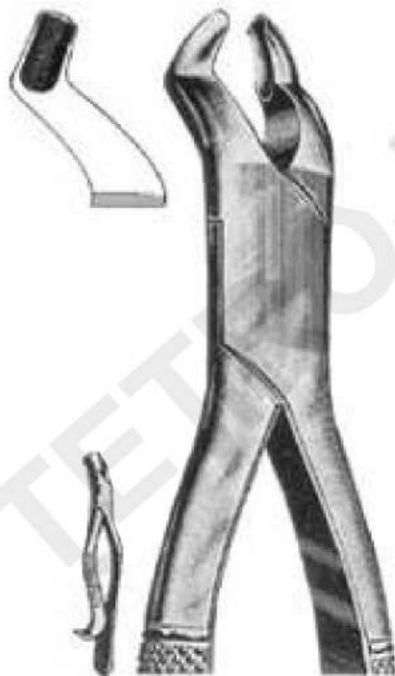

220

Fig.210H

Upper wisdoms with hook handle



221

Fig.210S

Upper wisdoms with straght handle

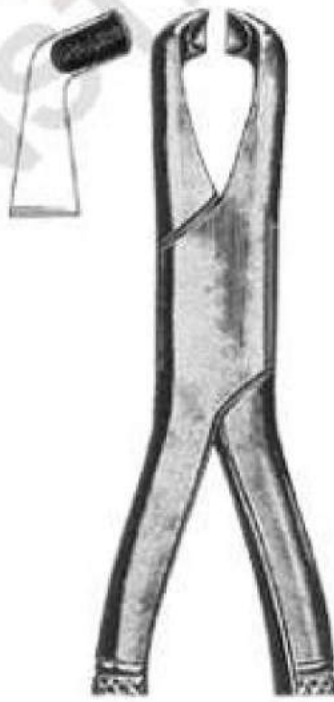

222

Fig.222

Lower wisdoms

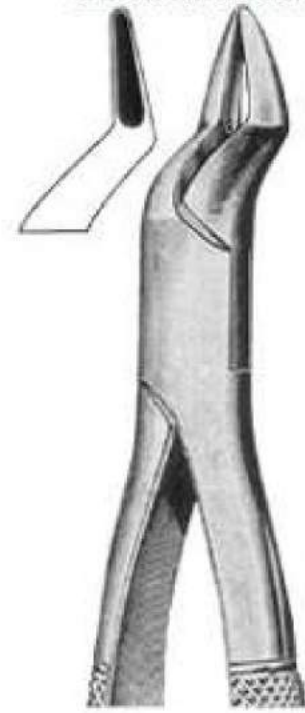

223

Fig.286

Upper roots premolars & incisors



Root Splinter Forceps

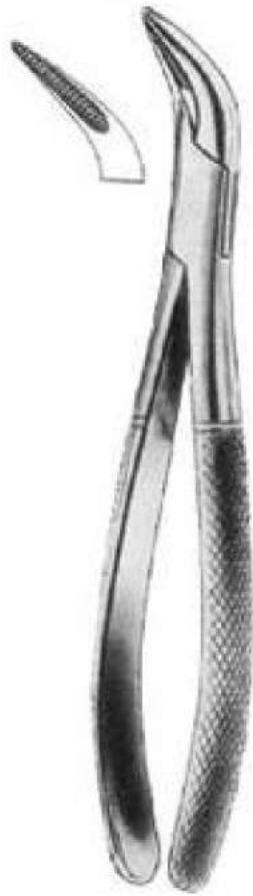

224
Fig. 1
Lower roots



225
Fig. 2
Upper roots



226
Albrecht 16cm



227
Albrecht 16cm

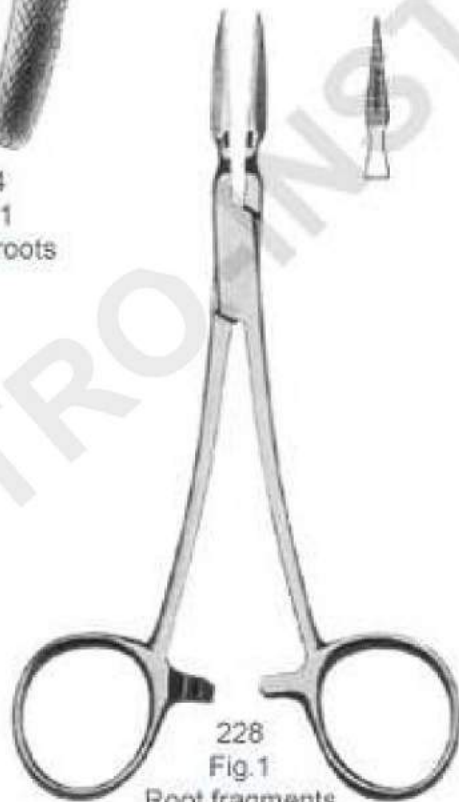

228
Fig. 1
Root fragments



229
Fig. 2
Root fragments



Boon Rongeurs



230
Blumenthal
15cm



231
Blumenthal 45
14.5 cm

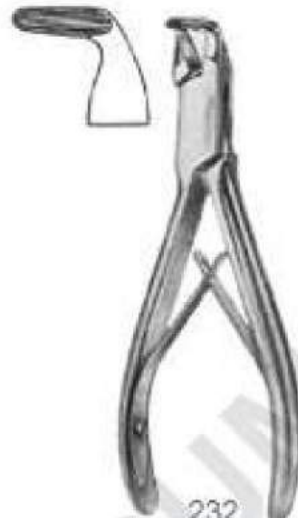

232
Blumenthal 99
14cm



233
Mead A1
16.5



234
Beyer 18cm



235
Ruskin - mini
15.5cm



236
Luer 15cm



237
Friedman 14cm



238
Mini Friedman
12cm



TETRO SURGICAL

Manufacturers & Exporters of Dental, Surgical & Beautycare Instruments.

Root Elevator





TETRO SURGICAL

Manufacturers & Exporters of Dental, Surgical & Beautycare Instruments.

Root Elevator





TETRO SURGICAL

Manufacturers & Exporters of Dental, Surgical & Beautycare Instruments.

Root Elevator



269
Fig. A
Cogswell



270
Fig. B
Cogswell



271
Fig. 301
Apexo



272
Fig. 302
Apexo



273
Fig. 303
Apexo



274
Fig. 301W
Seldin



275
Fig. 304W
Seldin



276
Fig. 1H
Heidbrink



277
Fig. 2H
Heidbrink



278
Fig. 40H
Heidbrink



279
Fig. 41H
Heidbrink



280
Fig. 46



281
Fig. 46R



TETRO SURGICAL

Manufacturers & Exporters of Dental, Surgical & Beautycare Instruments.

Root Elevator





TETRO SURGICAL

Manufacturers & Exporters of Dental, Surgical & Beautycare Instruments.

Root Elevator





TETRO SURGICAL

Manufacturers & Exporters of Dental, Surgical & Beautycare Instruments.

Root Elevator



313
Fig. 1
Bein



314
Fig. 2
Bein



315
Fig. 3
Bein



316
Fig. 4
Bein



317
Fig. 5
Bein



318
Fig. 6
Bein



319
Fig. 1



320
Fig. 2



321
Fig. 2
Flohr



322
Fig. 3
Flohr



323
Fig. 3
Cryer



324
Fig. 8
Cryer



Root Elevator





TETRO SURGICAL

Manufacturers & Exporters of Dental, Surgical & Beautycare Instruments.

Plier for Orthodontics & Prosthetics

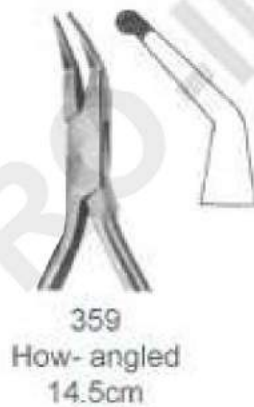



TETRO SURGICAL

Manufacturers & Exporters of Dental, Surgical & Beautycare Instruments.

Plier for Orthodontics & Prosthetics





Extracting Forceps



363
Peeso
13.5



364
Peeso
13.5cm



365
14cm



366
Langenbeck
14cm



367
14cm



368
13cm



369
Angle
12.5cm



370
Andresen
13cm



371
13.5cm



372
Schwarz
13.5cm

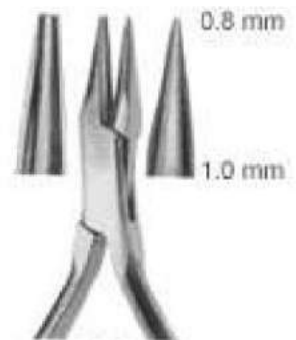

373
Fischer
13cm



Orthodontic Instruments





Orthodontic Instruments



392
Mathieu pliers
14cm



393
Elastic ligature placing
pliers
14cm



394
Elastic ligature placing
pliers 14cm



395
Mathieu pliers with
finger ring 14cm

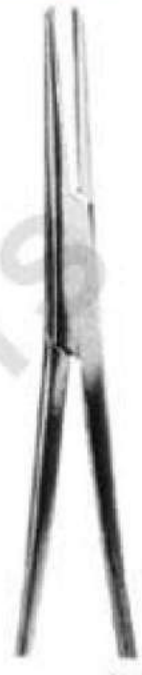

396
Mosquito
pliers



398
Bracket placing
tweezer



399
Bracket placing
tweezer



397
Brack positioning gauge

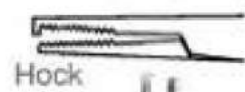

Hock

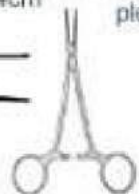

403
Mosquito
Forceps



400
Ligature tying piler



401
Band seating instruments



402
Bracket holding tweezers



nylon



Gum Scissors



404 Fig. 1
12cm Straight

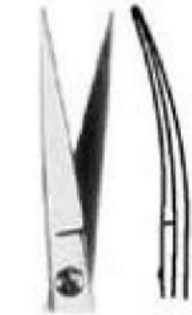

405
Fig. 2
12cm Straight



406
Fig. 1
13 cm
Goldman-Fox. Saw
edge Straight



407
Fig. 2
Goldman-fox swa edge
curved



408
Fig. 1
Iris Straight



409
Fig. 2
11.5cm
Iris Curved



410
Fig. 3
11.5cm
Iris

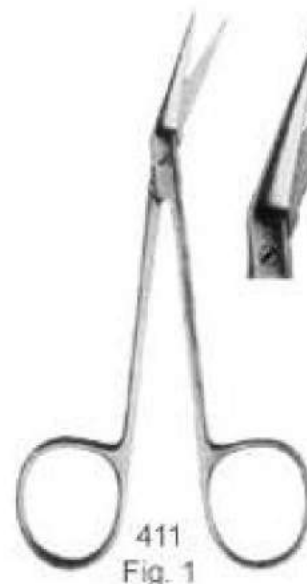

411
Fig. 1
11.5cm
Angular Saw edge



412
Fig. 2
11.5cm
Angular



Gum Scissors



413
Fig. 1
La Grange 11.5cm

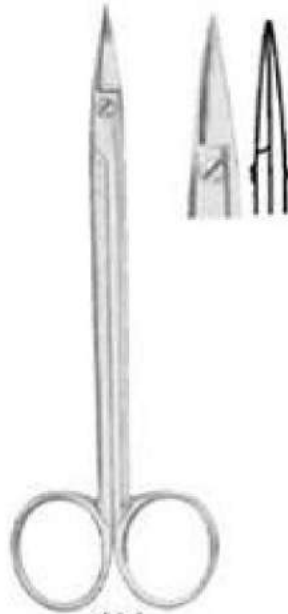

414
Fig. 1
Quinby 12.5cm

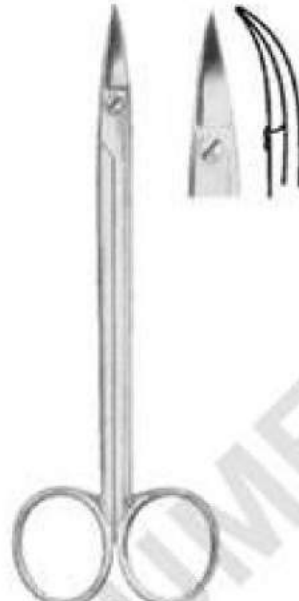

415
Fig. 2
Quinby 12.5cm



416
Fig. 3
Goldman-fox (special) 12.5cm



417
Fig. 1
Kelly 16cm



418
Fig. 2
Kelly 16cm



419
Fig. 1
Locklin 16.5cm

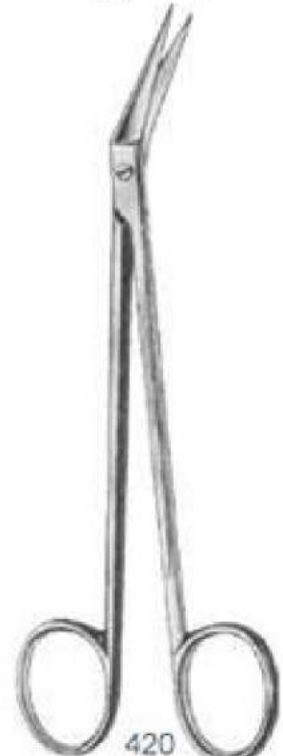

420
Fig. 2
Locklin 16.5cm



Surgical Scissors



421
Fig. 1
Noyes (Castroaviejo)
12cm



422
Fig. 1
14.5cm



423
Fig. 1
Westcott
11cm



424
Fig. 2
Westcott
11cm



425
Fig. 1
Spencer 9cm



426
Fig. 2
Spencer 13cm

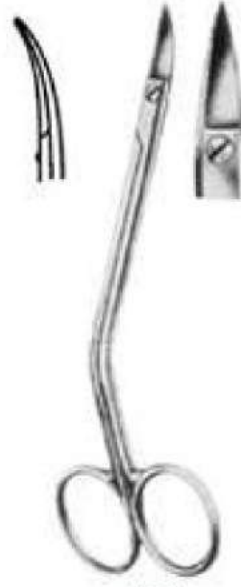

427
Fig. 1
Neumann 12.5cm

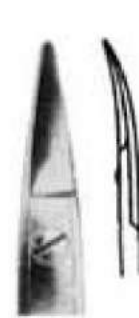

428
Fig. 1
Dean 17cm



Gum Scissors

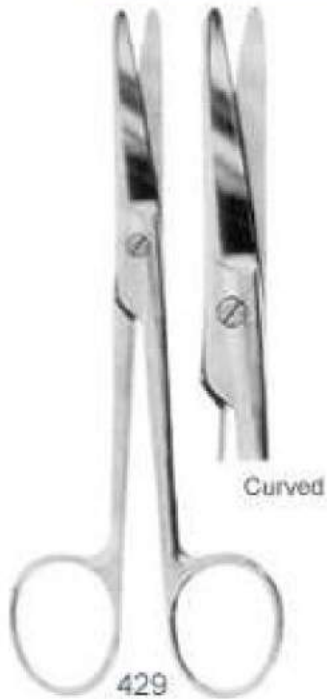

429
Fig. 1
Mayo
14.5cm

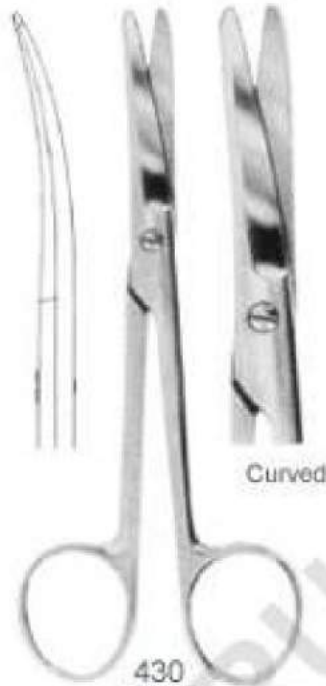

430
Fig. 2
Mayo
14.5cm



431
Fig. 2
Metzenbaum
14.5cm



432
Fig. 2
Metzenbaum
14.5cm



433
Fig. 2
Metzenbaum-delicate
14.5cm

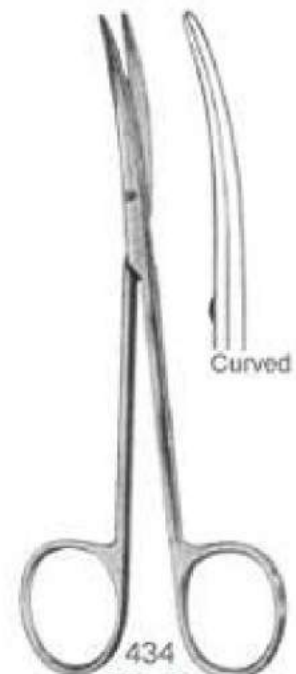

434
Fig. 2
Metzenbaum-delicate
14.5cm



TETRO SURGICAL

Manufacturers & Exporters of Dental, Surgical & Beautycare Instruments.

Haemostatic Forceps

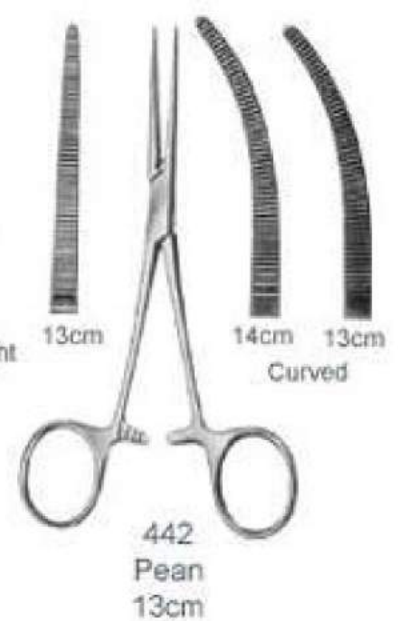
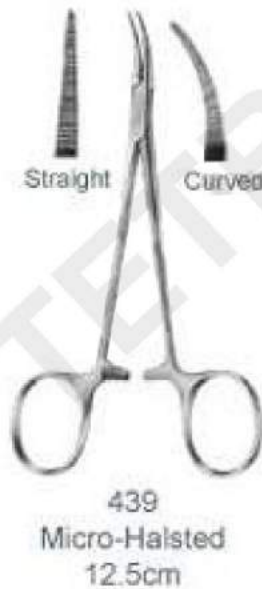
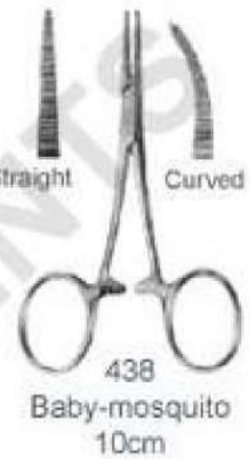
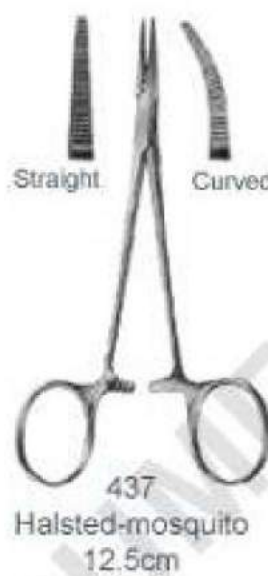
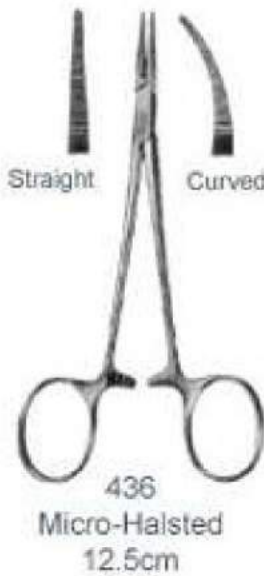
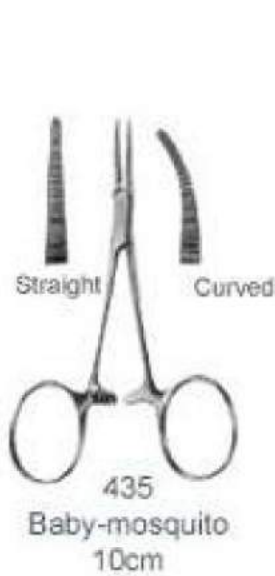



Haemostatic Forceps

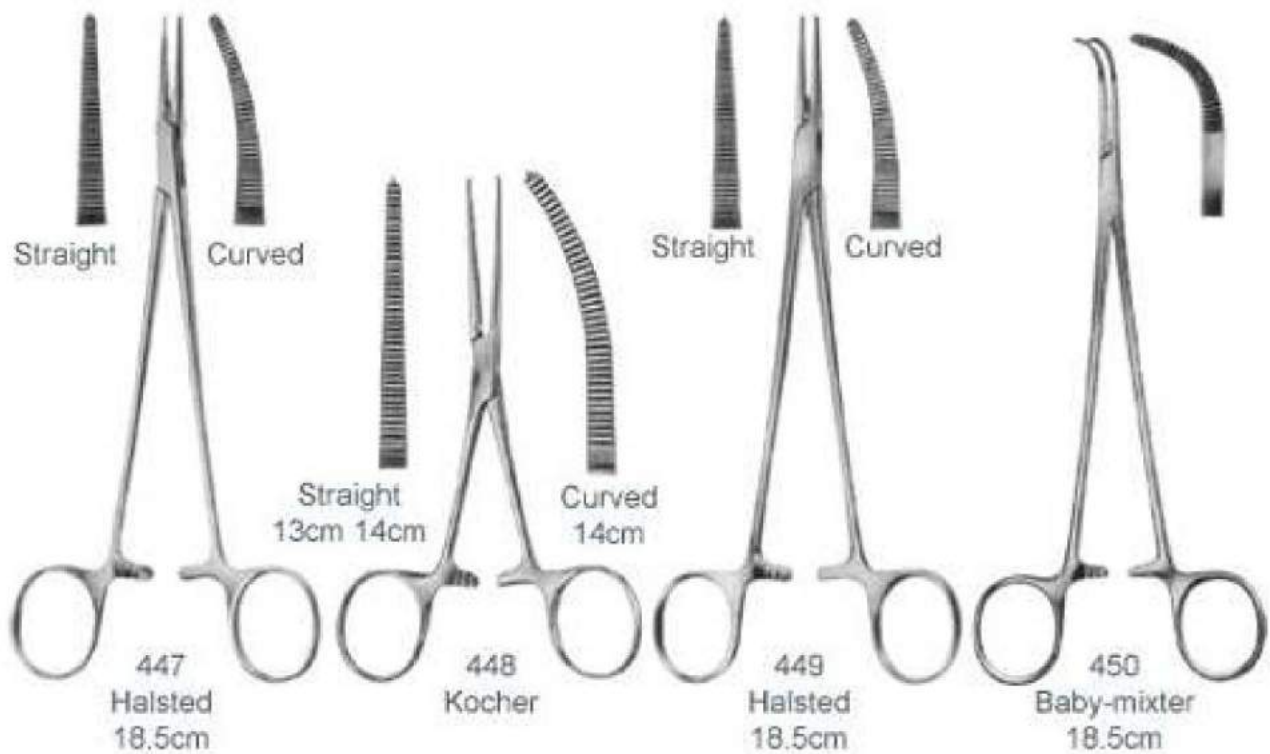
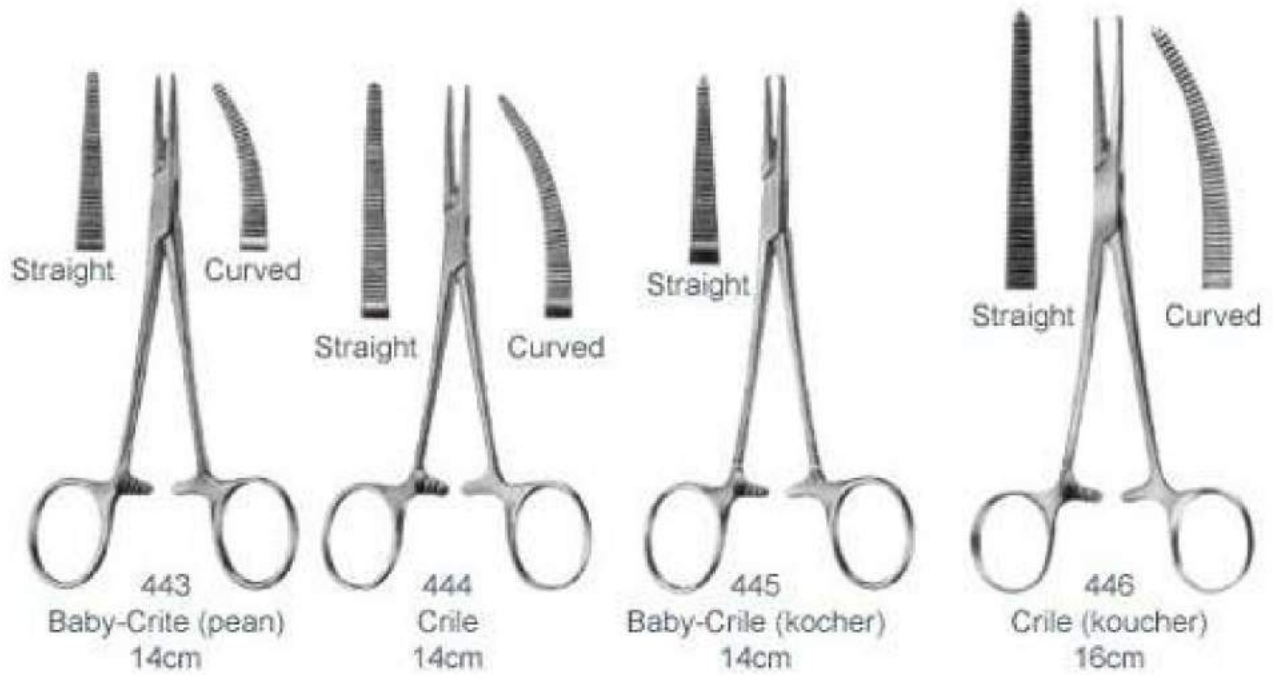



Sponge & Dressing Forceps

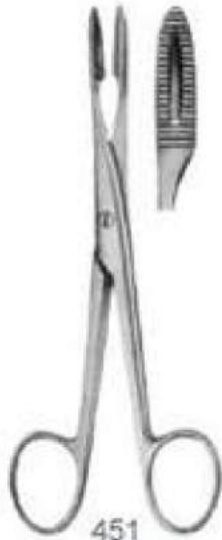

451
Without Ratchet
14c.5m



452
With Ratchet
14.5cm



453
Curved
17.5cm



454
Curved
21cm



455
Without Ratchet
18cm

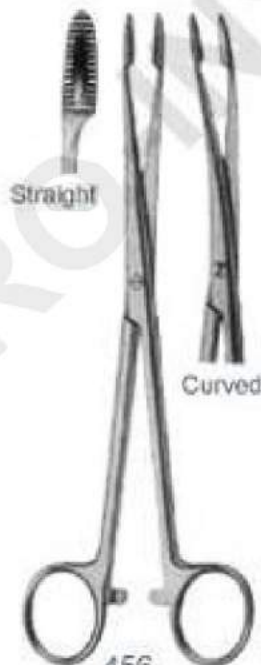

456
With Ratchet
18cm

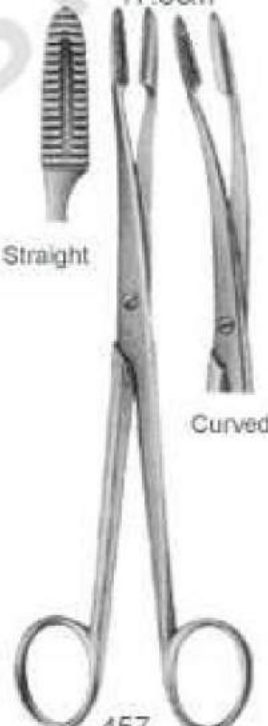

457
Without Ratchet
20cm

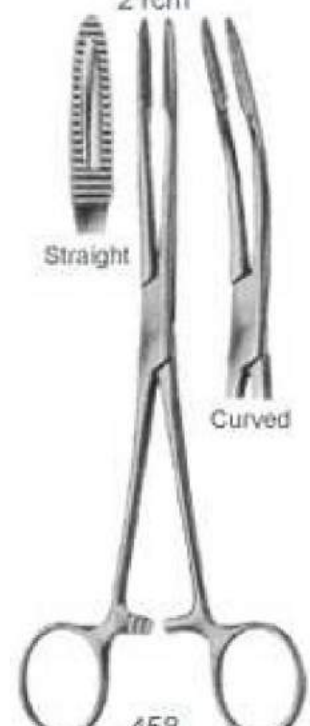

458
With Ratchet
20cm



Needle Holders



Designed for Frontal & Palate Suture





TETRO SURGICAL

Manufacturers & Exporters of Dental, Surgical & Beautycare Instruments.

Needle Holders



465
Mathieu
14cm



466
Mathieu
14cm



467
Boynton
12cm



468
Castroviejo
14cm

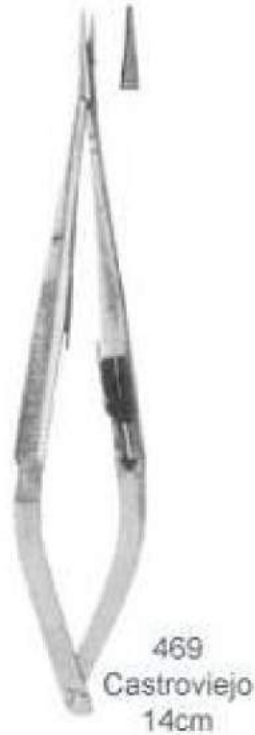

469
Castroviejo
14cm



470
Castroviejo
13cm



471
Arruga
13cm



Towel Clamps





TETRO SURGICAL

Manufacturers & Exporters of Dental, Surgical & Beautycare Instruments.

Skin Hook & Retractor





TETRO SURGICAL

Manufacturers & Exporters of Dental, Surgical & Beautycare Instruments.

Retractor





TETRO SURGICAL

Manufacturers & Exporters of Dental, Surgical & Beautycare Instruments.

Retractor





TETRO SURGICAL

Manufacturers & Exporters of Dental, Surgical & Beautycare Instruments.

Cheek Retractor

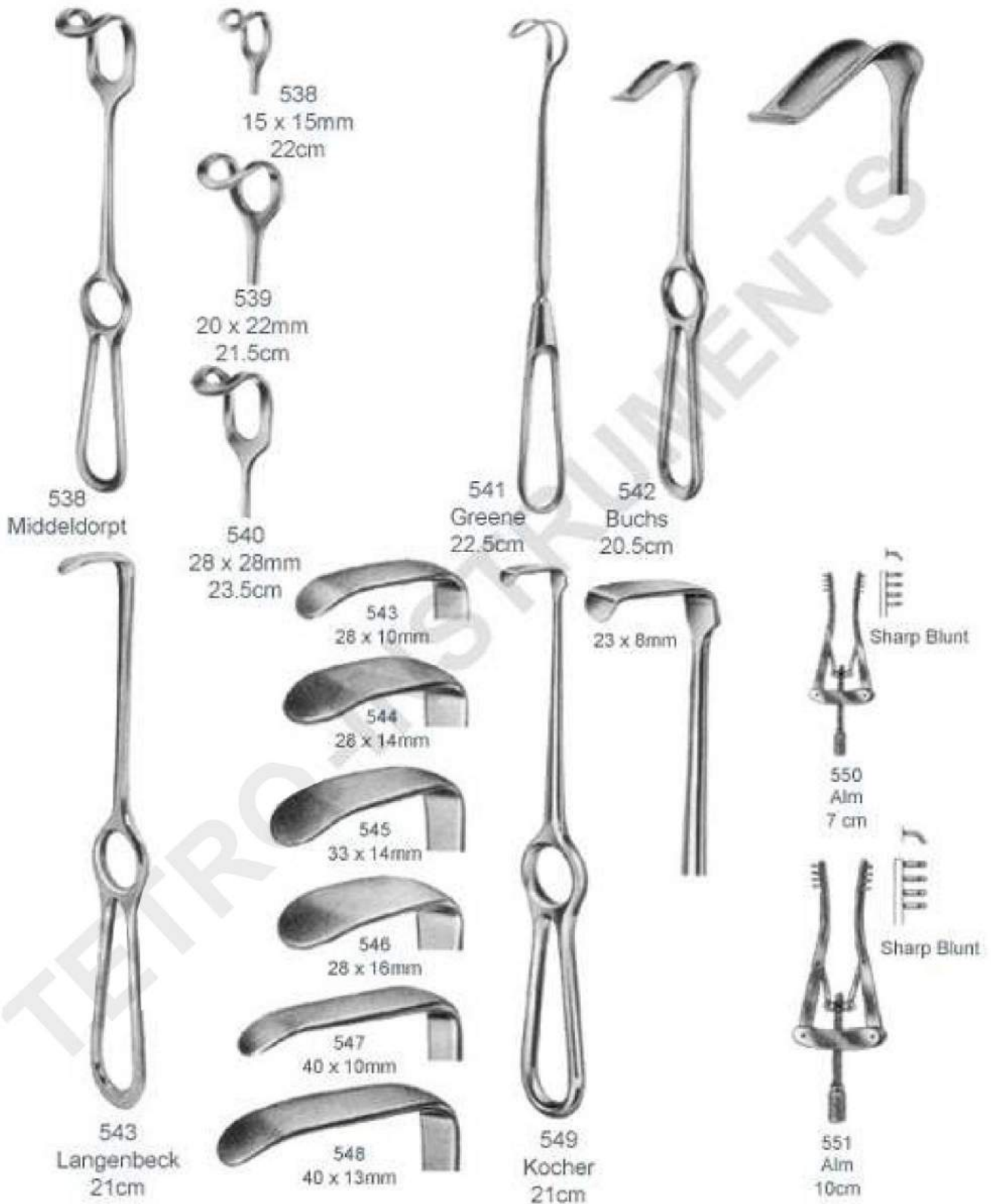



TETRO SURGICAL

Manufacturers & Exporters of Dental, Surgical & Beautycare Instruments.

Elevators





Raspatories





TETRO SURGICAL

Manufacturers & Exporters of Dental, Surgical & Beautycare Instruments.

Elevators

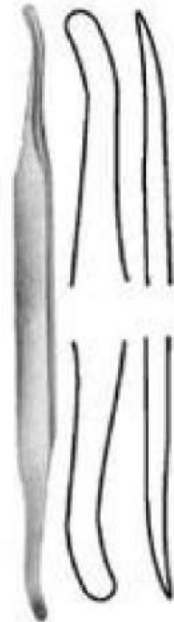

574
Seldin
19.5cm

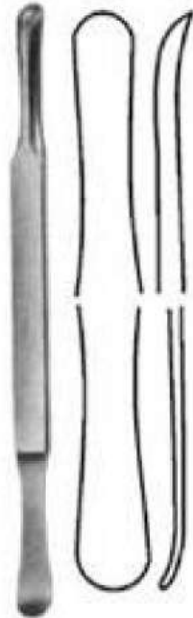

575
Seldin
19.5 cm



576
Chompret
15cm



577 578

579 580

4 mm



581
Freer
16cm

4 mm



582
Freer
16cm

4 mm

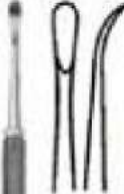

583
Parsch, mod
14.5cm



584
Mead
16.5cm



585
Mead
18cm



TETRO SURGICAL

Manufacturers & Exporters of Dental, Surgical & Beautycare Instruments.

Chisel & Gouges

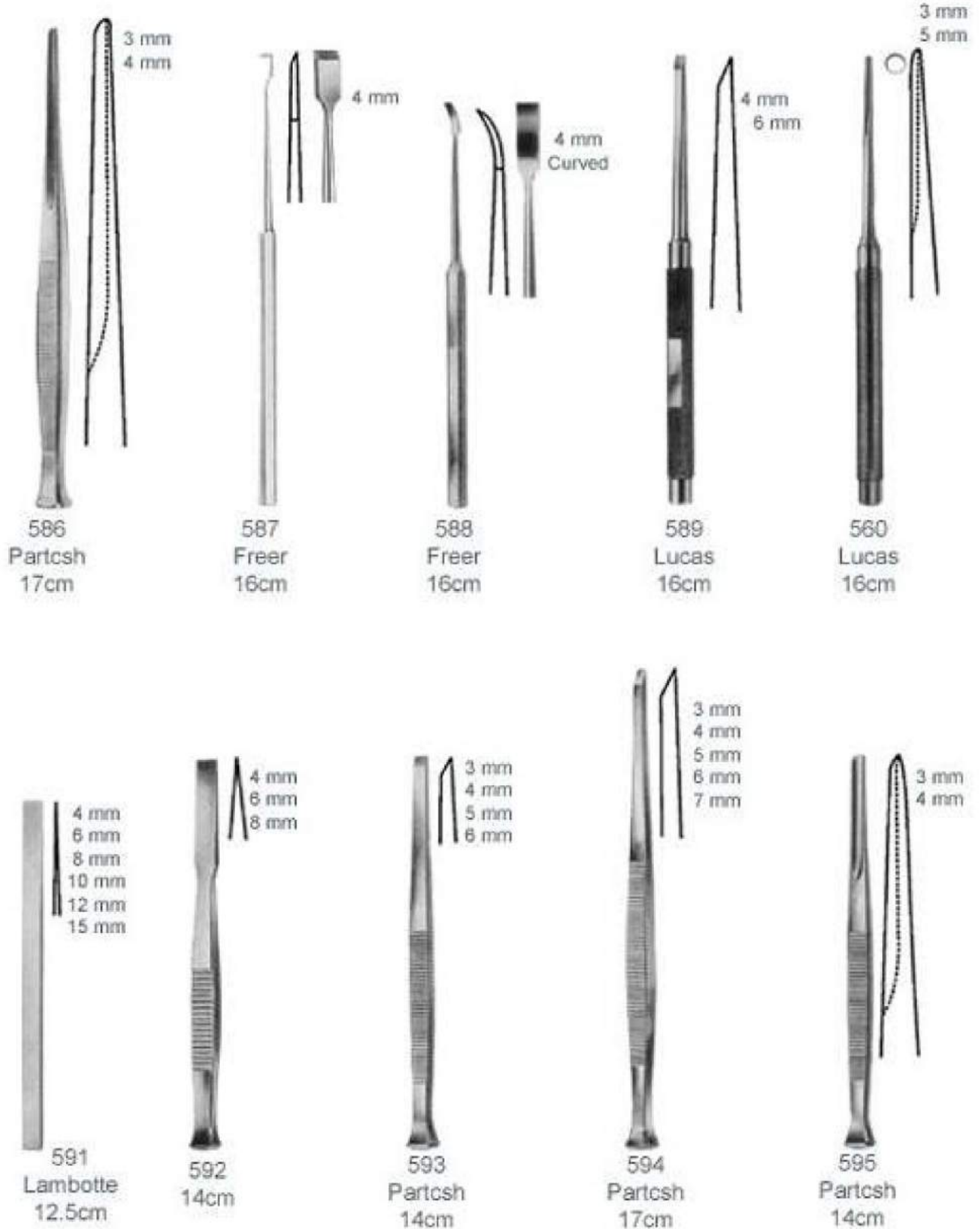



Rubber Dam Instruments

Calmp forceps



596
Ivory light weight
17cm

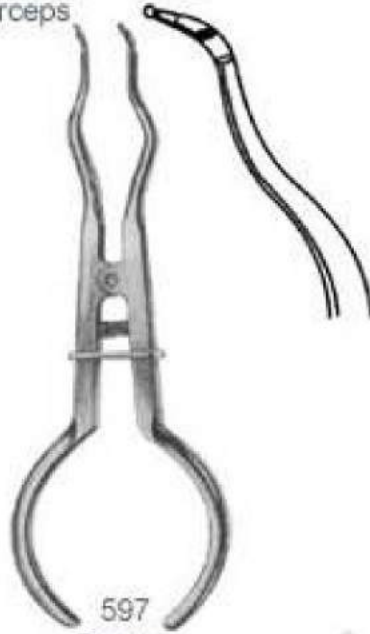

597
Brewer
17.5cm

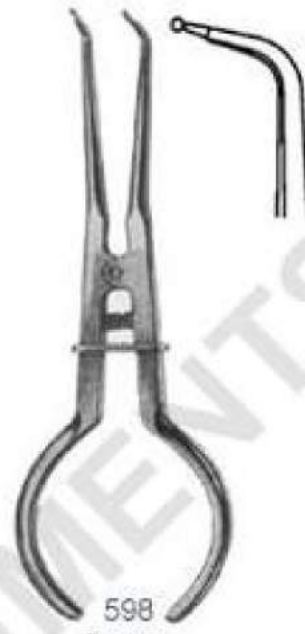

598
Stokes
17.5cm

Punch Forceps



599
Ainsworth
17cm



600
Ivory
17cm

Rubber dam frame

601



Tissue Pliers

602
Fig.1
Adson, 12cm



603
Fig.1
Adson 1 x 2, 12cm



604
Fig.1
Semken-Taylor
12.5cm



605
Fig.2
Semken-Taylor
12.5cm



606
Fig.1
Semken-Taylor 1x2
12.5cm



607
Fig.1
Semken-Taylor 1x2
12.5cm



608
Fig.2
12cm



609
11.5cm



610
11.5cm



611
11.5cm





Cotton & Dressing Pliers

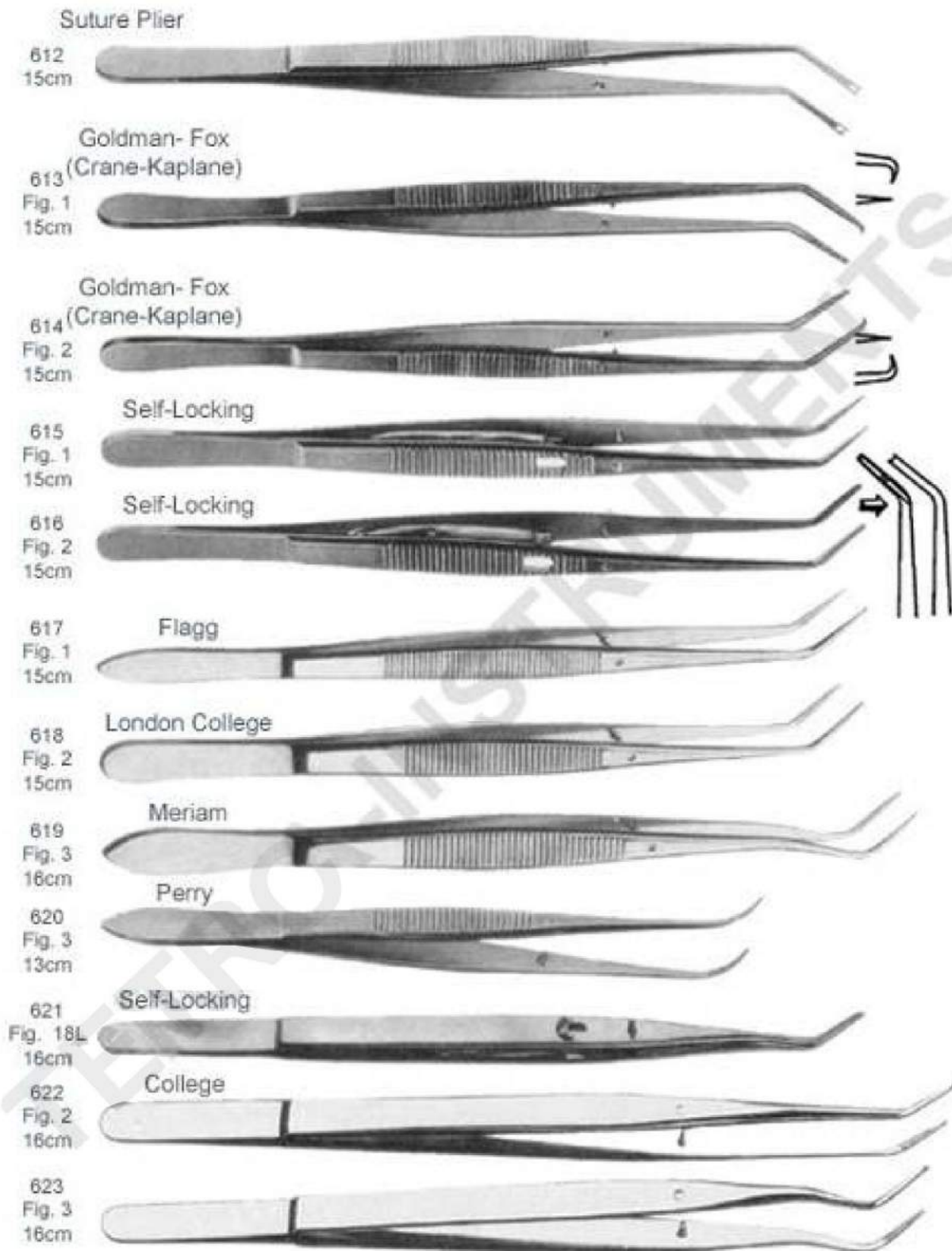



TETRO SURGICAL

Manufacturers & Exporters of Dental, Surgical & Beautycare Instruments.

Mouth Mirrors



624
Plane 4
22mm
Plane 5
24mm



625
Magnifying 4
22mm
Magnifying 5
24mm



626
Plane 4
22mm
Plane 5
24mm



627
Magnifying 4
22mm
Magnifying 5
24mm
With cone-socket



628



629
Hollow



630



631



TETRO SURGICAL

Manufacturers & Exporters of Dental, Surgical & Beautycare Instruments.

Scalpal Handle



632
Fig. 3L



633
Fig. 7



634
Fig. 5



635
Fig. 5A



636
Fig. 3



637
Fig. 3G



638
Fig. 4



TETRO SURGICAL

Manufacturers & Exporters of Dental, Surgical & Beautycare Instruments.

Handles Reference Guide



A

Single ended
Knurling round



B

Double ended
Knurling round

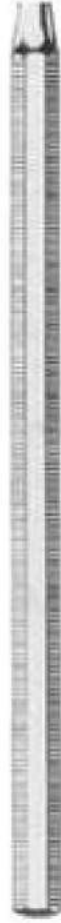

C

Single ended
octangle
ssserted tangle



D

Double ended
serrated



E

Single ended
hollow round



F

Double ended
hollow round



G

Double ended
hollow round grooved



H

Double ended
swiss pattern octangle



Explorers



640
Fig. 23



640
Fig. 2



641
Fig. 16



642
Fig. 9



643
Fig. 10



644
Fig. 12



645
Fig. 11



646
Fig. 6



647
Fig. 8



648
Fig. 5



649
Fig. 17



650
Fig. 17A



651
Fig. 3



652
Fig. 3A



653
Fig. 1
Spreader



654
Fig. 2
Spreader



655
Fig. 3
Spreader



656
Fig. 4
Spreader



657
Fig. 5
Spreader



658
Fig. 6
Spreader



659
Fig. 7
Spreader



TETRO SURGICAL

Manufacturers & Exporters of Dental, Surgical & Beautycare Instruments.

Priodontal Pocket Probs





TETRO SURGICAL

Manufacturers & Exporters of Dental, Surgical & Beautycare Instruments.

Priodontal Pocket Probs





TETRO SURGICAL

Manufacturers & Exporters of Dental, Surgical & Beautycare Instruments.

Priondental Pocket Probs





TETRO SURGICAL

Manufacturers & Exporters of Dental, Surgical & Beautycare Instruments.

Filling Instruments

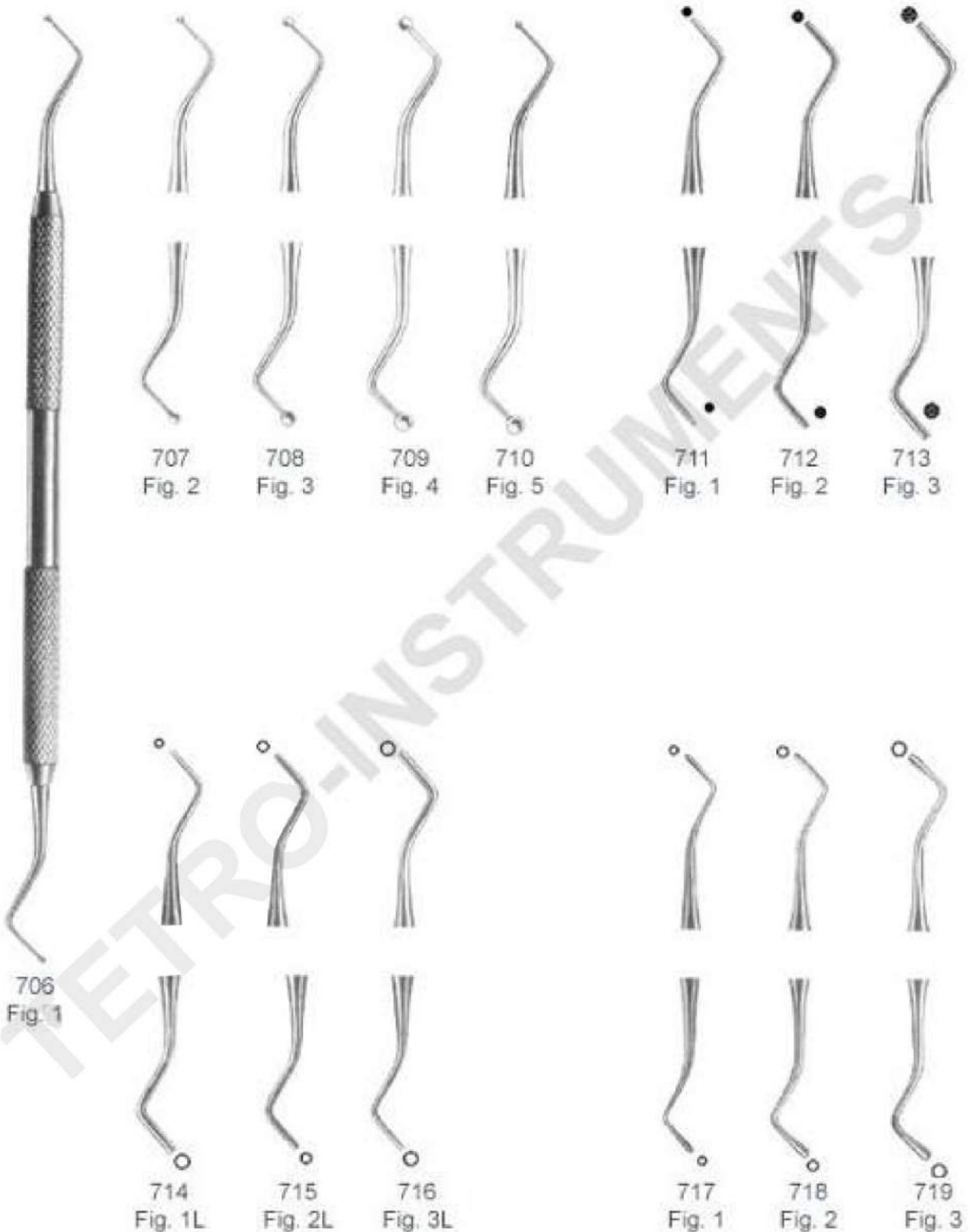



TETRO SURGICAL

Manufacturers & Exporters of Dental, Surgical & Beautycare Instruments.

Filling Instruments

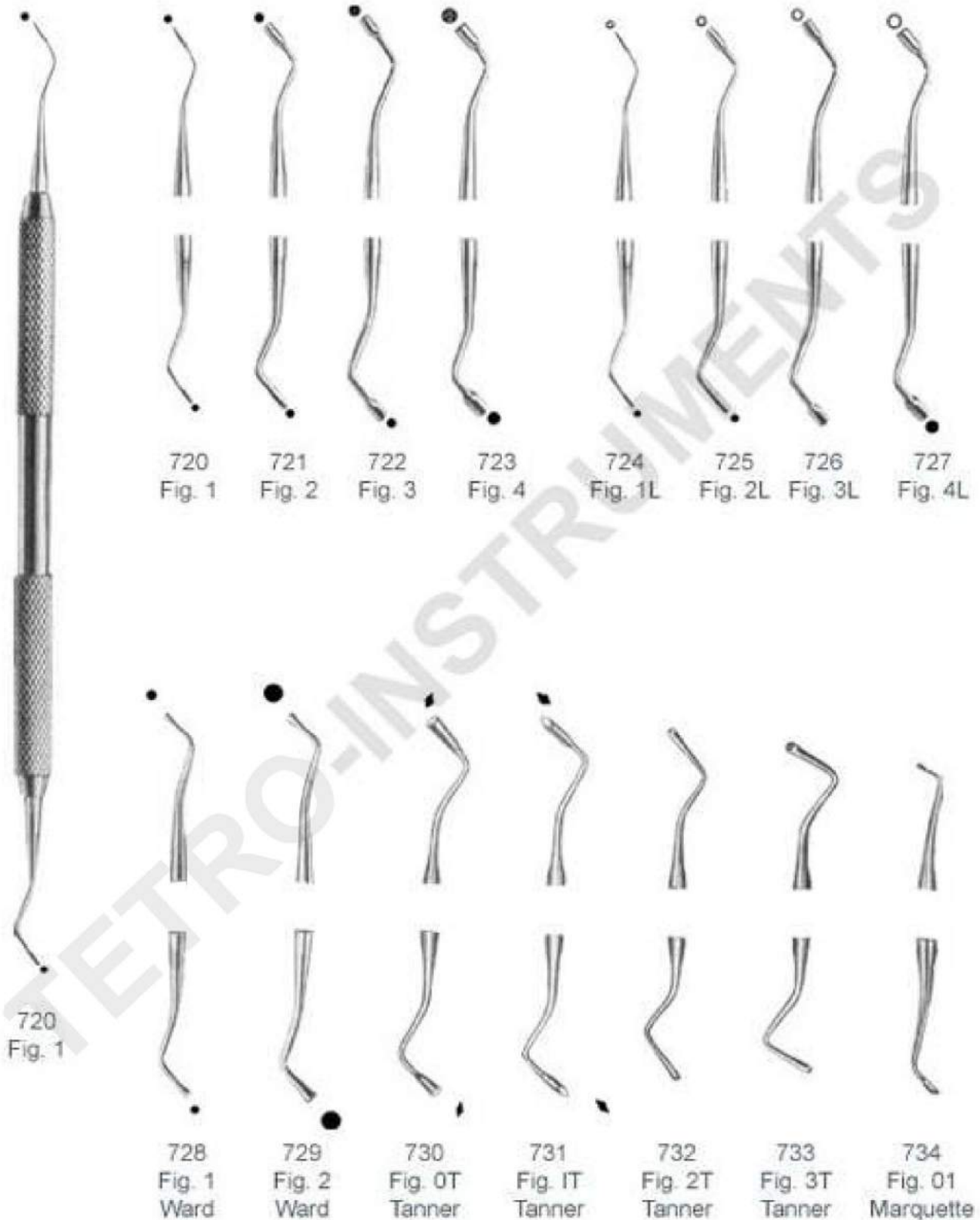



TETRO SURGICAL

Manufacturers & Exporters of Dental, Surgical & Beautycare Instruments.

Filling Instruments

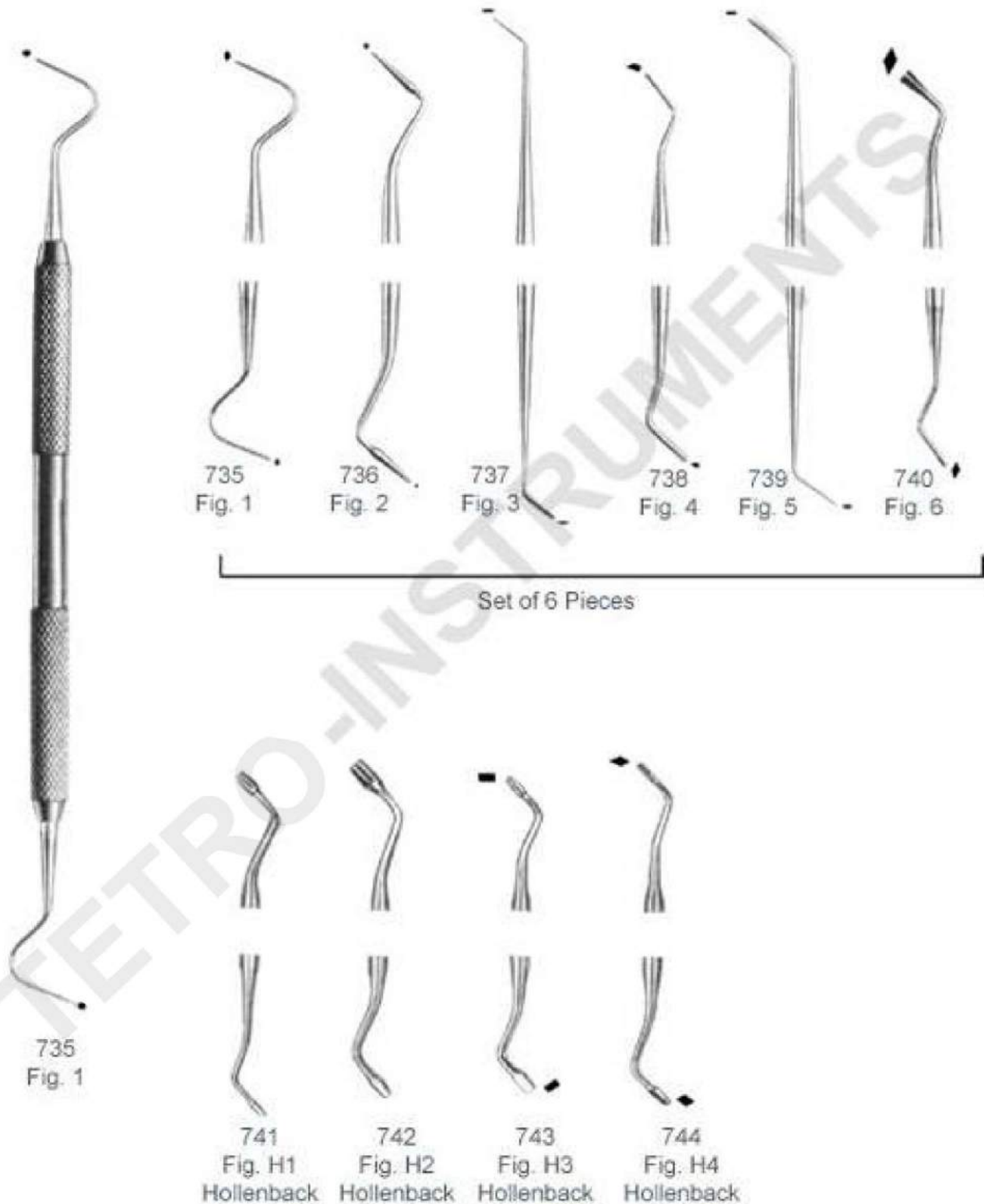



Filling Instruments



Plastic Filling Instruments





TETRO SURGICAL

Manufacturers & Exporters of Dental, Surgical & Beautycare Instruments.

Plastic Filling Instruments

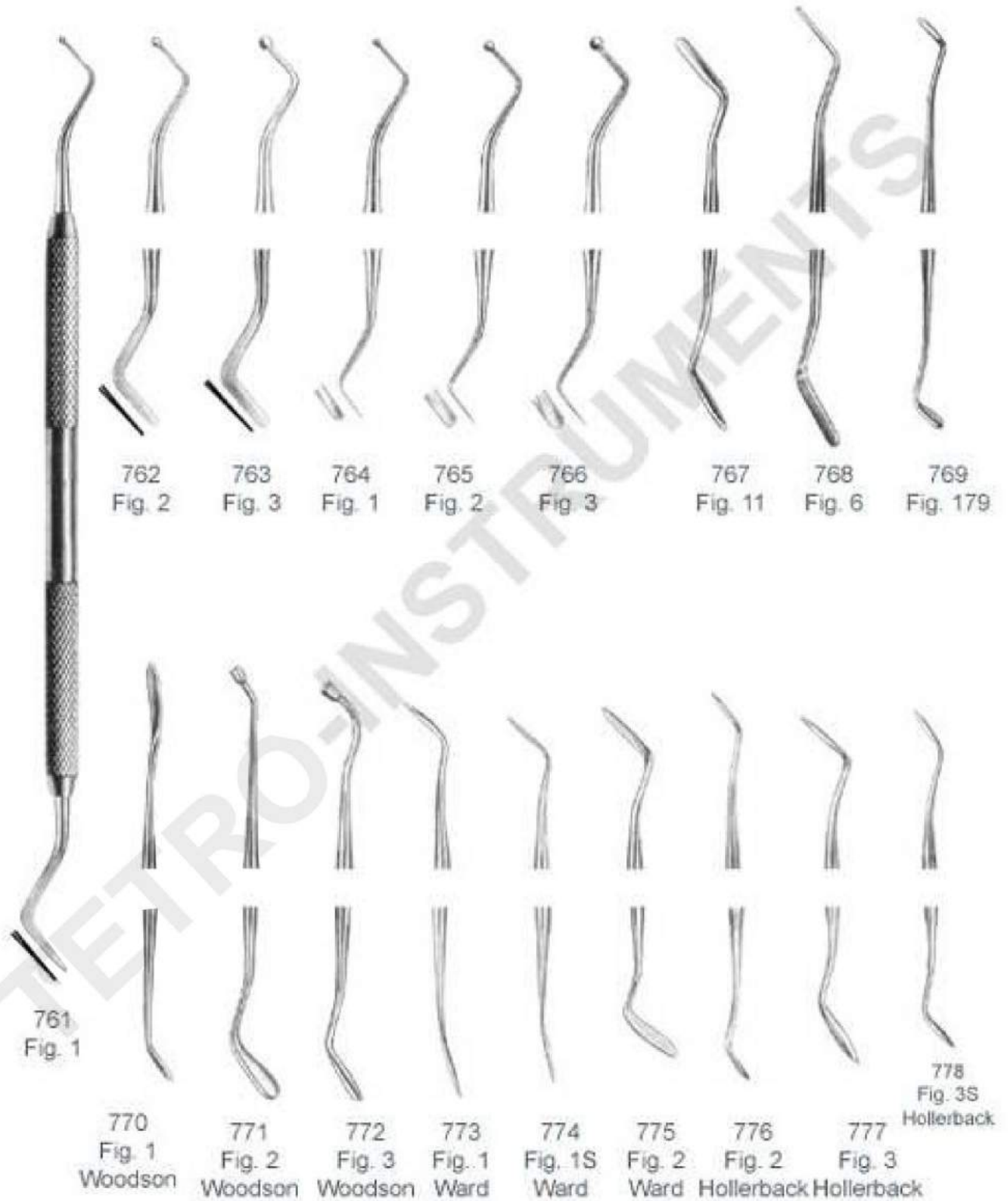



Amalgam Curvers

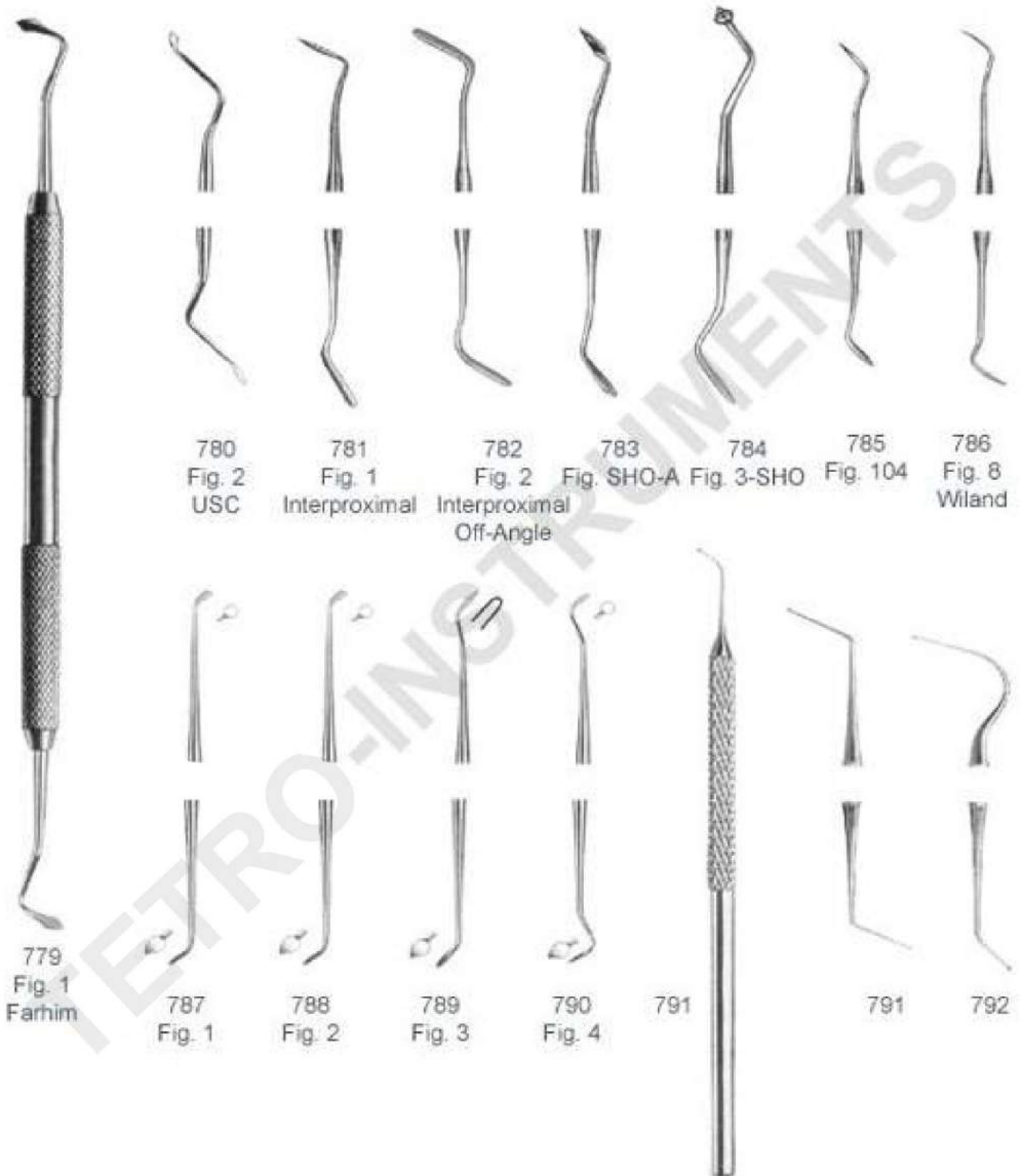



TETRO SURGICAL

Manufacturers & Exporters of Dental, Surgical & Beautycare Instruments.

Cavity Preparation Instruments

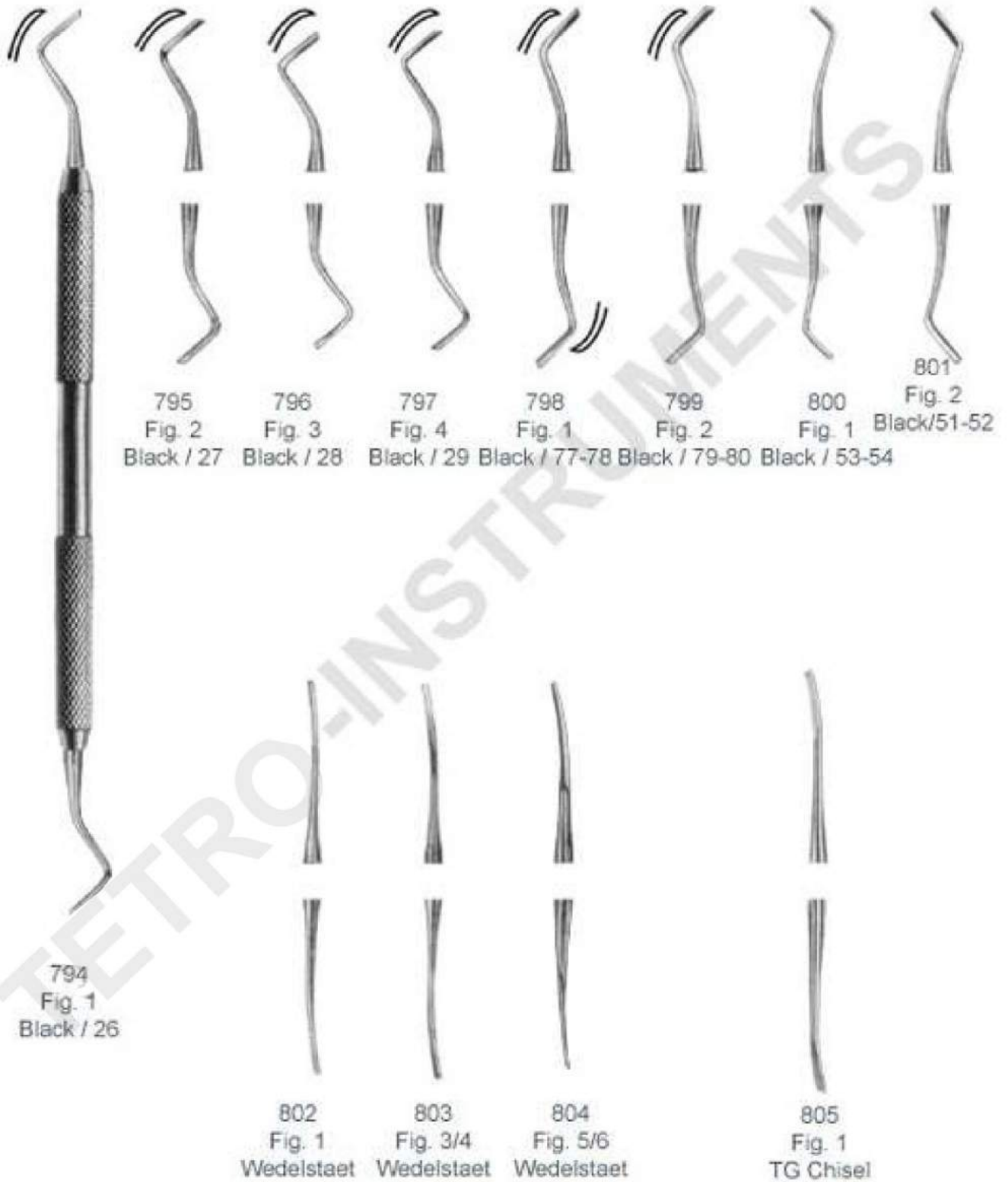



TETRO SURGICAL

Manufacturers & Exporters of Dental, Surgical & Beautycare Instruments.

Excavator



806
Fig. 6



807
Fig. 14



808
Fig. 17



809
Fig. 17W
Oval Spoon



810
Fig. 18



811
Fig. 18W
Oval Spoon



812
Fig. 19



813
Fig. 19W
Oval Spoon

025- 175S Set of 5



814
Fig. 0



815
Fig. 1



816
Fig. 2



817
Fig. 3



818
Fig. 4



819
Fig. 1



820
Fig. 2



TETRO SURGICAL

Manufacturers & Exporters of Dental, Surgical & Beautycare Instruments.

Excavator

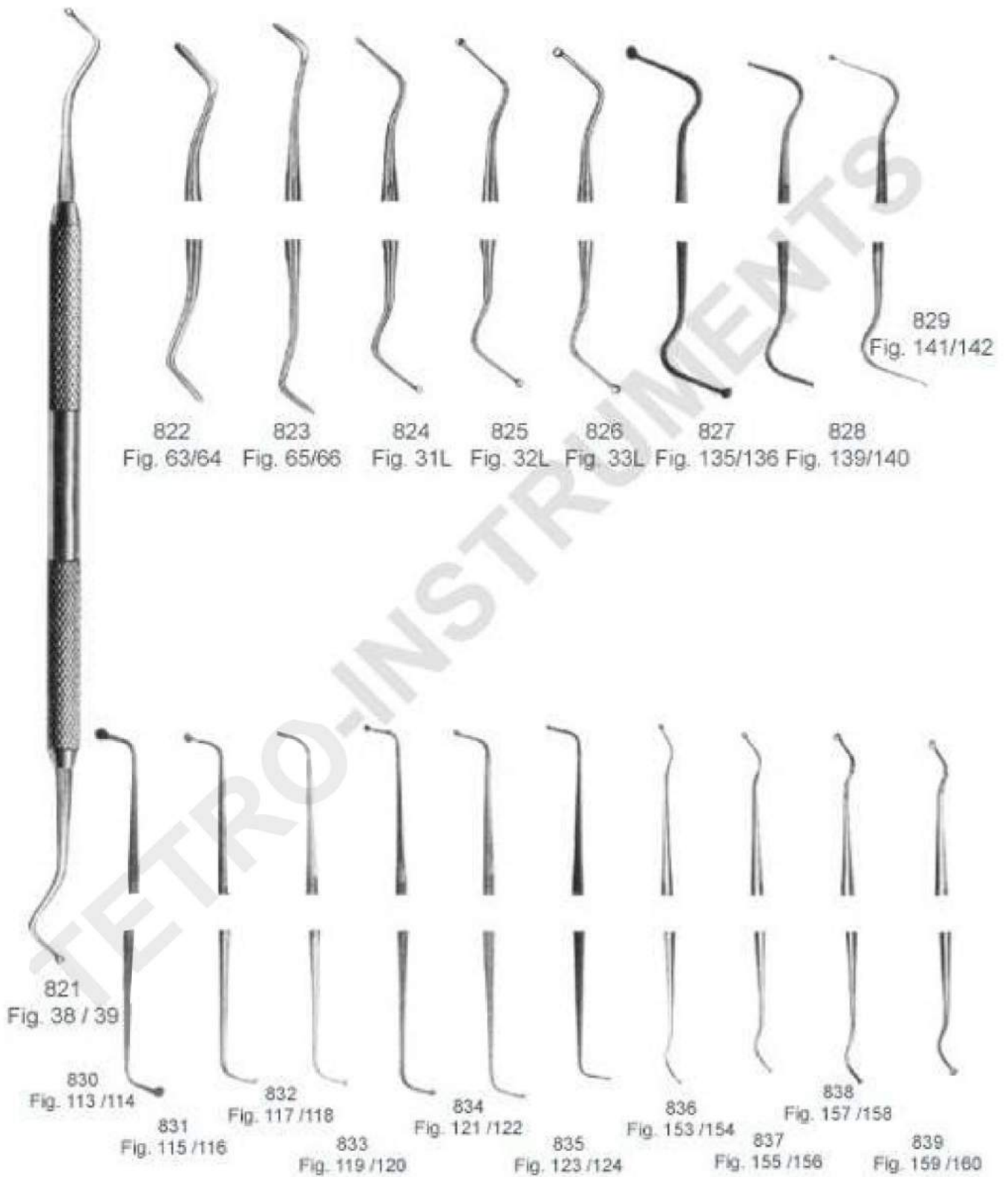



TETRO SURGICAL

Manufacturers & Exporters of Dental, Surgical & Beautycare Instruments.

Excavator



840 Fig. 125/126 841 Fig. 127/128 842 Fig. 129/130 843 Fig. 131/132 844 Fig. 133/134 845 Fig. 9/10 846 Fig. 204/205 847 Fig. 206/207 848 Fig. 208/209



840 Fig. 125/126



849 Fig. 210/211 850 Fig. 212/213 851 Fig. 214/215 852 Fig. 216/217 853 Fig. 218/219 854 Fig. 220/221 855 Fig. 243 856 Fig. 244 857 Fig. 245 858 Fig. 246



TETRO SURGICAL

Manufacturers & Exporters of Dental, Surgical & Beautycare Instruments.

Periodontal Instruments



859
Fig. M9
Molt

860
Fig. 1
Hopkins

861
Fig. 2
Hopkins

862
Fig. 3
Mead

863
Fig. 3
Prichard

864
Fig. Pr3
Freer

865
Fig. 16
Freer



TETRO SURGICAL

Manufacturers & Exporters of Dental, Surgical & Beautycare Instruments.

Bone Files

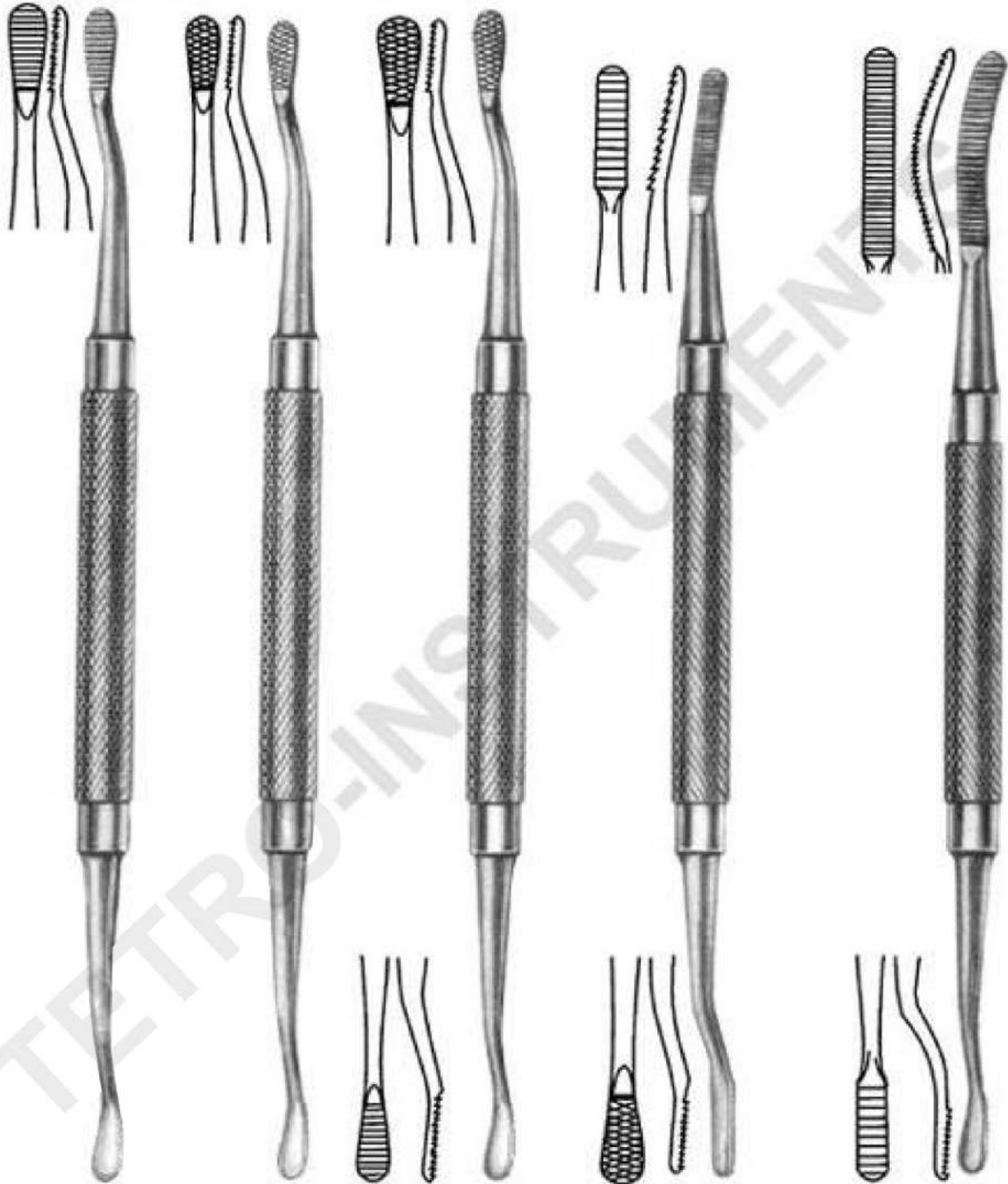

866
Fig. 12 CA

867
Fig. 12A

868
Fig. 12
Howard

869
Fig. 33

870
Fig. 45
Miller



TETRO SURGICAL

Manufacturers & Exporters of Dental, Surgical & Beautycare Instruments.

Bone Files



871
Fig. 1
Whal



872
Fig. 2
Whal

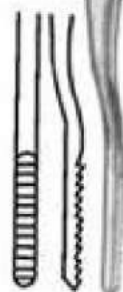
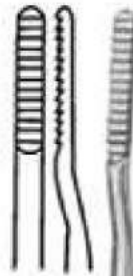

873
Fig. 1
Polokoff

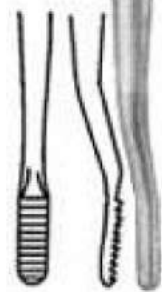
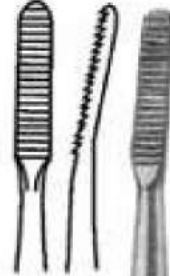

874
Fig. 64
Miller

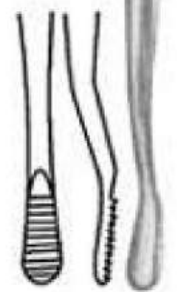
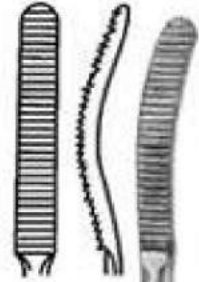

875
Fig. 10



TETRO SURGICAL

Manufacturers & Exporters of Dental, Surgical & Beautycare Instruments.

Bone Curetes

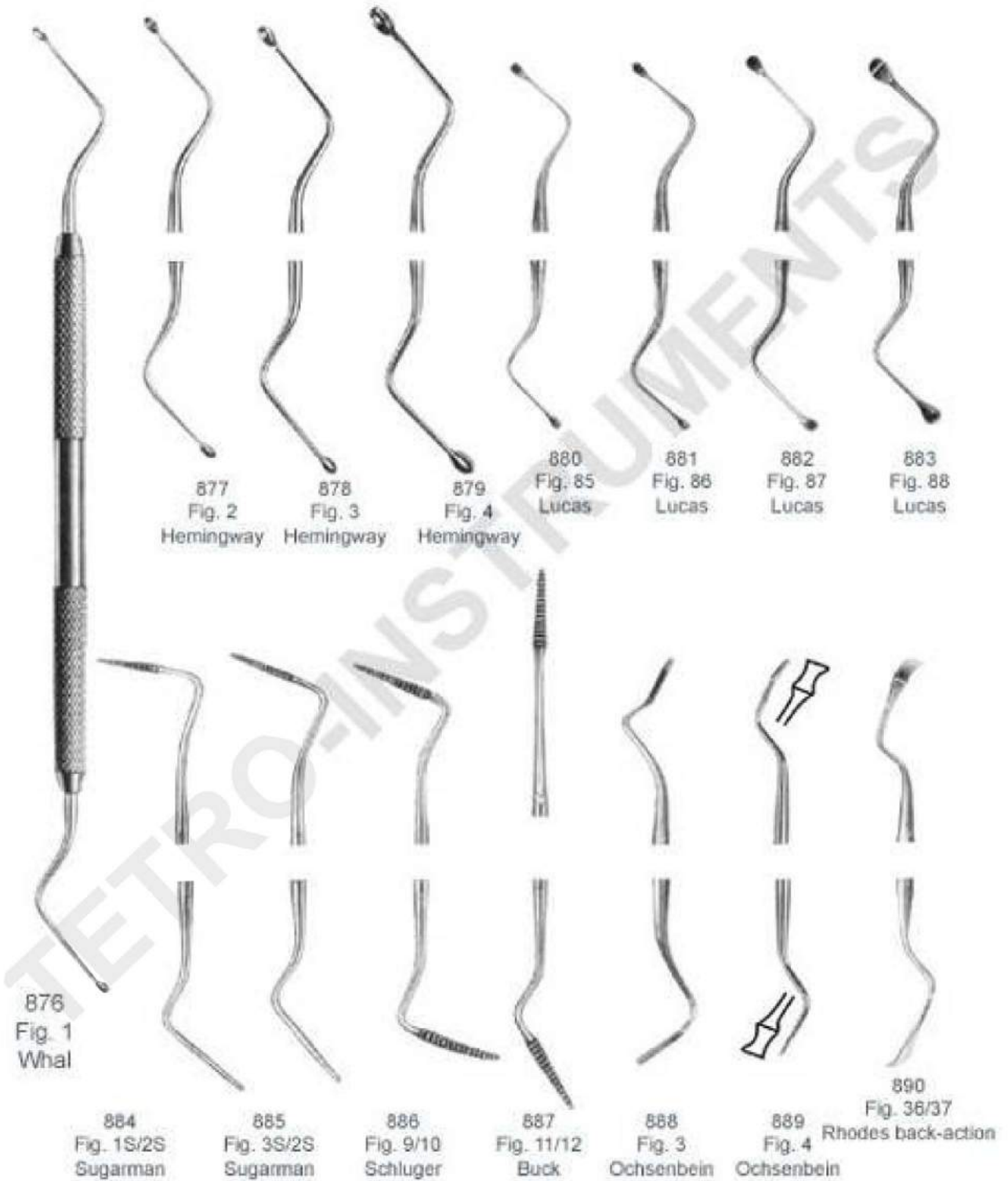



Periodontal Instruments





Periodontal Instruments

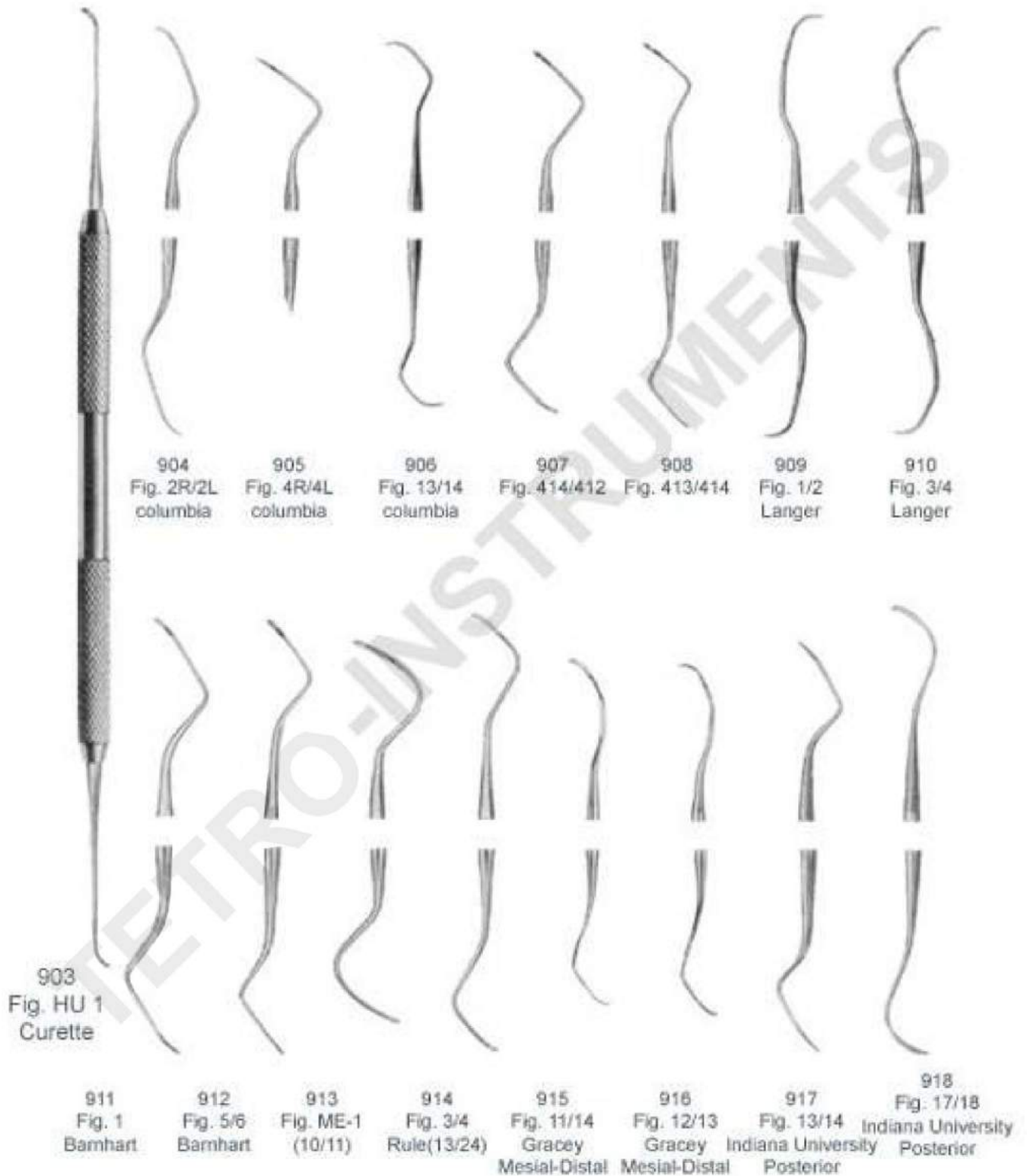



TETRO SURGICAL

Manufacturers & Exporters of Dental, Surgical & Beautycare Instruments.

Periodontal Instruments

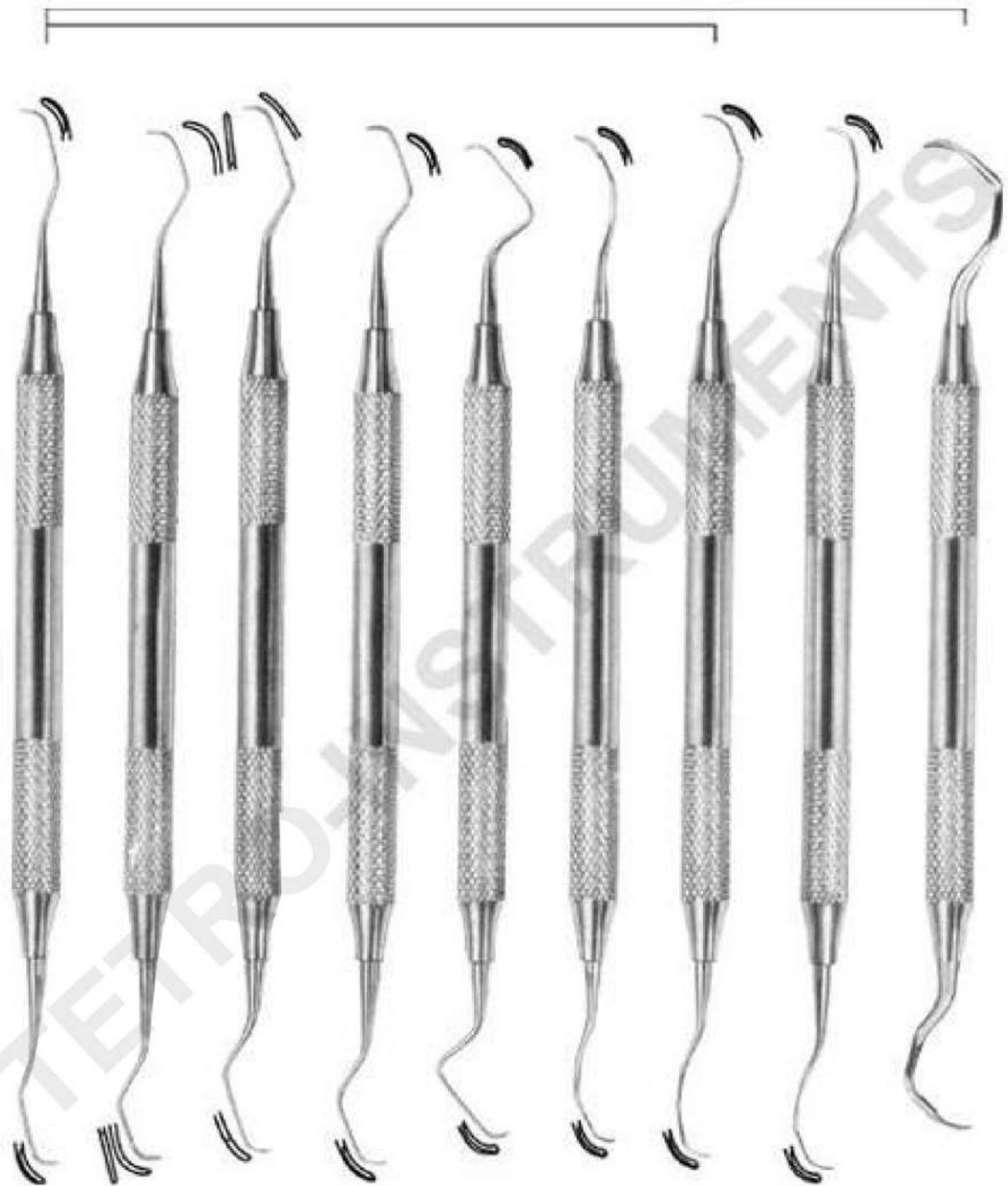

919	920	921	922	923	924	925	926	927
Fig. 1/2	Fig. 3/4	Fig. 5/6	Fig. 7/8	Fig. 9/10	Fig. 11/12	Fig. 13/14	Fig. 15/16	Fig. 17/18
Gracey	Gracey	Gracey	Gracey	Gracey	Gracey	Gracey	Gracey	Gracey



Periodontal Instruments

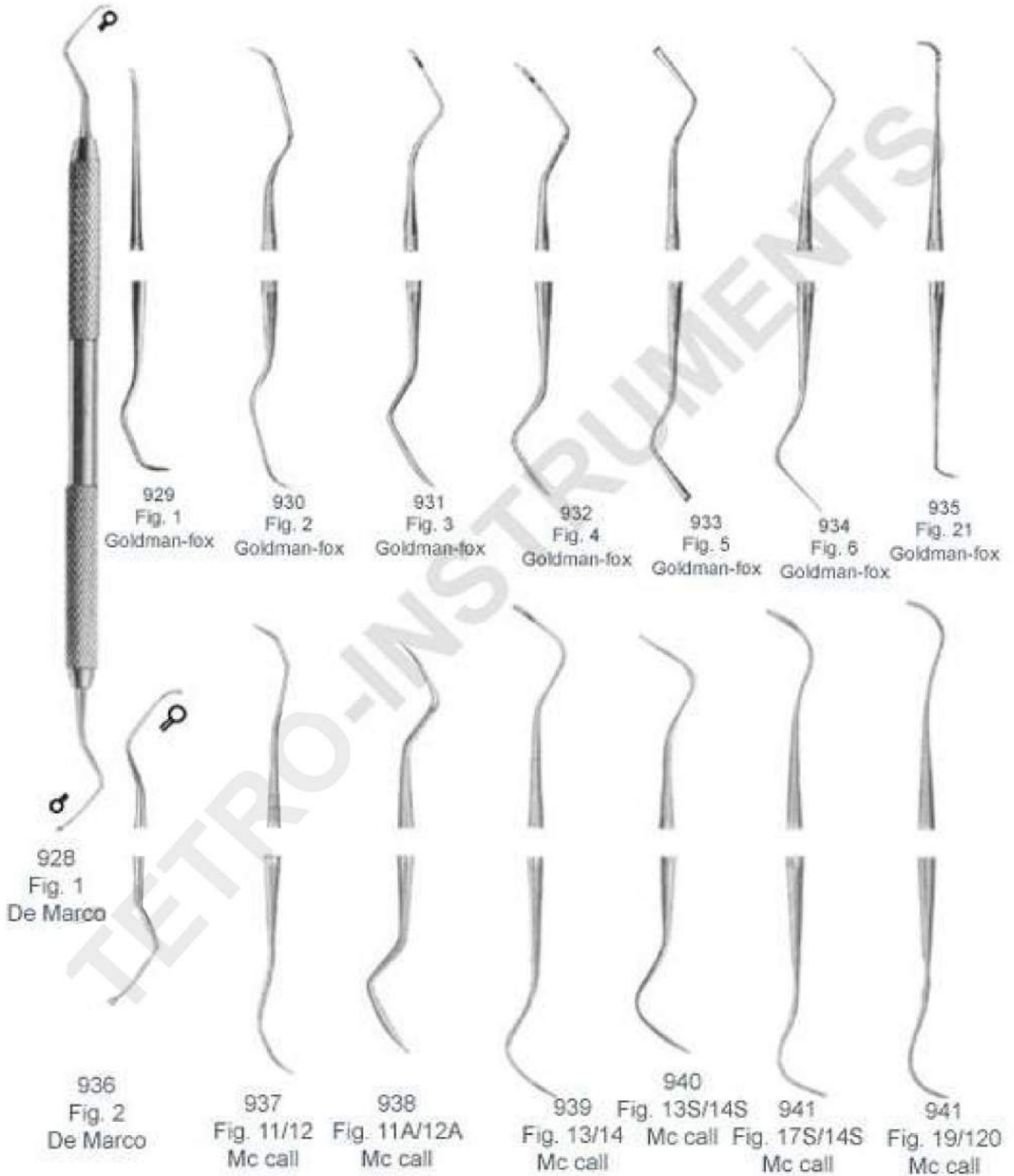



TETRO SURGICAL

Manufacturers & Exporters of Dental, Surgical & Beautycare Instruments.

Periodontal Instruments

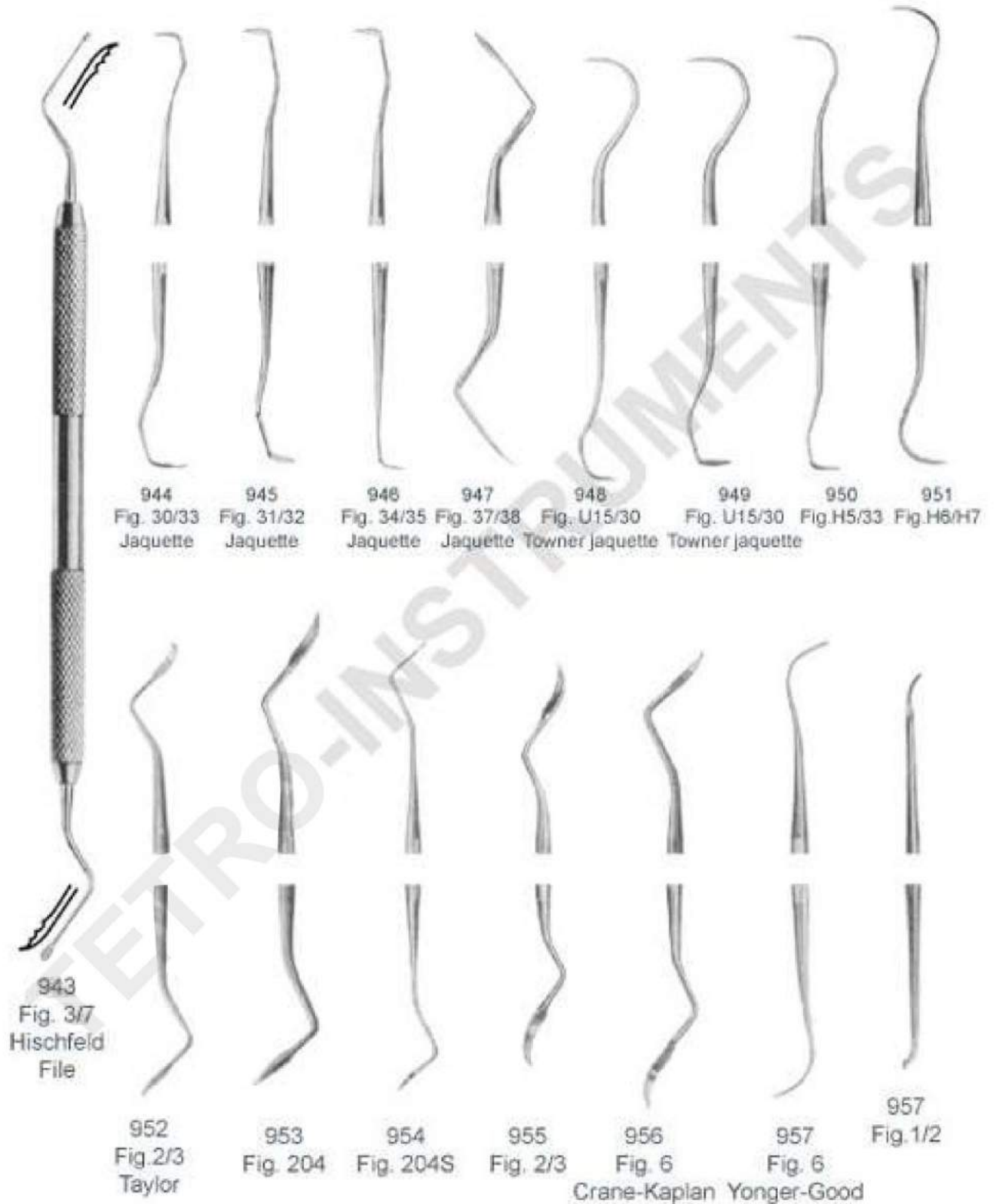



TETRO SURGICAL

Manufacturers & Exporters of Dental, Surgical & Beautycare Instruments.

Periodontal Instruments





TETRO SURGICAL

Manufacturers & Exporters of Dental, Surgical & Beautycare Instruments.

Cement Spatula





TETRO SURGICAL

Manufacturers & Exporters of Dental, Surgical & Beautycare Instruments.

Vax Modeling Carvers





TETRO SURGICAL

Manufacturers & Exporters of Dental, Surgical & Beautycare Instruments.

Vax Modeling Carvers





TETRO SURGICAL

Manufacturers & Exporters of Dental, Surgical & Beautycare Instruments.

Vax Modeling Carvers





TETRO SURGICAL

Manufacturers & Exporters of Dental, Surgical & Beautycare Instruments.

Vax Knives



1012
Fig. 1
Fahnenstock
cm.12.5

1013
Fig. 1
Lessmann
cm.12.5

1014
Fig. 1
Con Scodelina

1015
Fig. 2
Fehnenstock

1016
Fig. 2
Lessmann

1017
Fig. 2
Con Scodelina



TETRO SURGICAL

Manufacturers & Exporters of Dental, Surgical & Beautycare Instruments.

Spatulas for Plaster and Alginate



1018
cm 17



1019
cm 17 Gritman



1020
cm 19.5



1021
cm 21.5



1022
cm 20.5



1023
cm 19.5



1024
cm 20

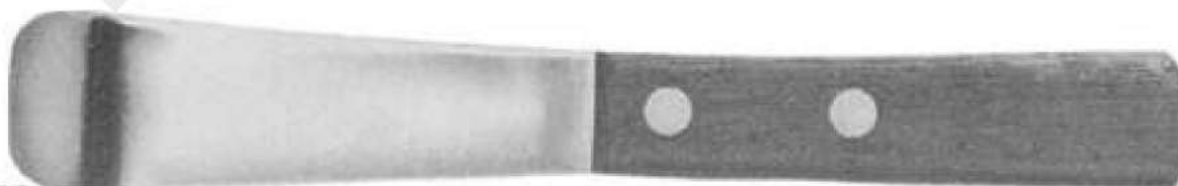

1025
cm 22.5



TETRO SURGICAL

Manufacturers & Exporters of Dental, Surgical & Beautycare Instruments.

Amalgam Cariers





TETRO SURGICAL

Manufacturers & Exporters of Dental, Surgical & Beautycare Instruments.

Wax & Modeling Carvers





TETRO SURGICAL

Manufacturers & Exporters of Dental, Surgical & Beautycare Instruments.

Chip Blower Water Syringes



1042
Chip blower



1043

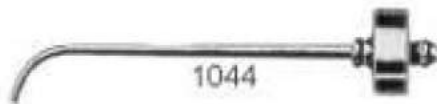

1044



1045

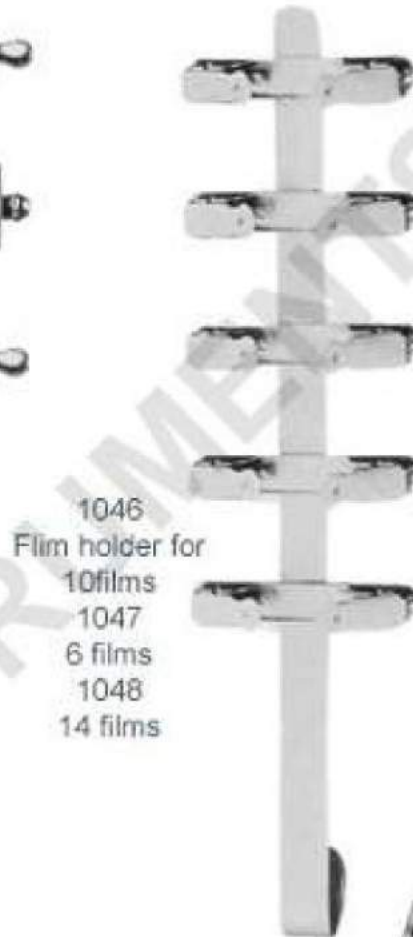

1046
Film holder for
10films
1047
6 films
1048
14 films



1049
Water syringe



1050
Water syringe



1051
Napkin holder with plastic
band

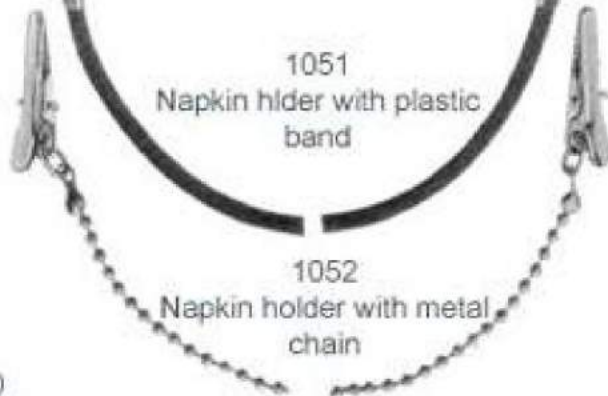

1052
Napkin holder with metal
chain



TETRO SURGICAL

Manufacturers & Exporters of Dental, Surgical & Beautycare Instruments.

Matrix Retainer



1053-5mm
1054-6mm
1055-7mm
Lovry8



1056
Ivory 8 N



1057
Ivory 8N



1058
Siqueland-
narrow 1059
Siqueland-wide



1060
Fig. 1
Toffemire-
universal



1061
Fig. 2
Toffemire-
senior



1062
Fig.
Toffemire-
junior



1063
Fig. 2
Didher 8



1064
Ivory



1065
Ivory



1066
Ivory Separator



Crown Instruments

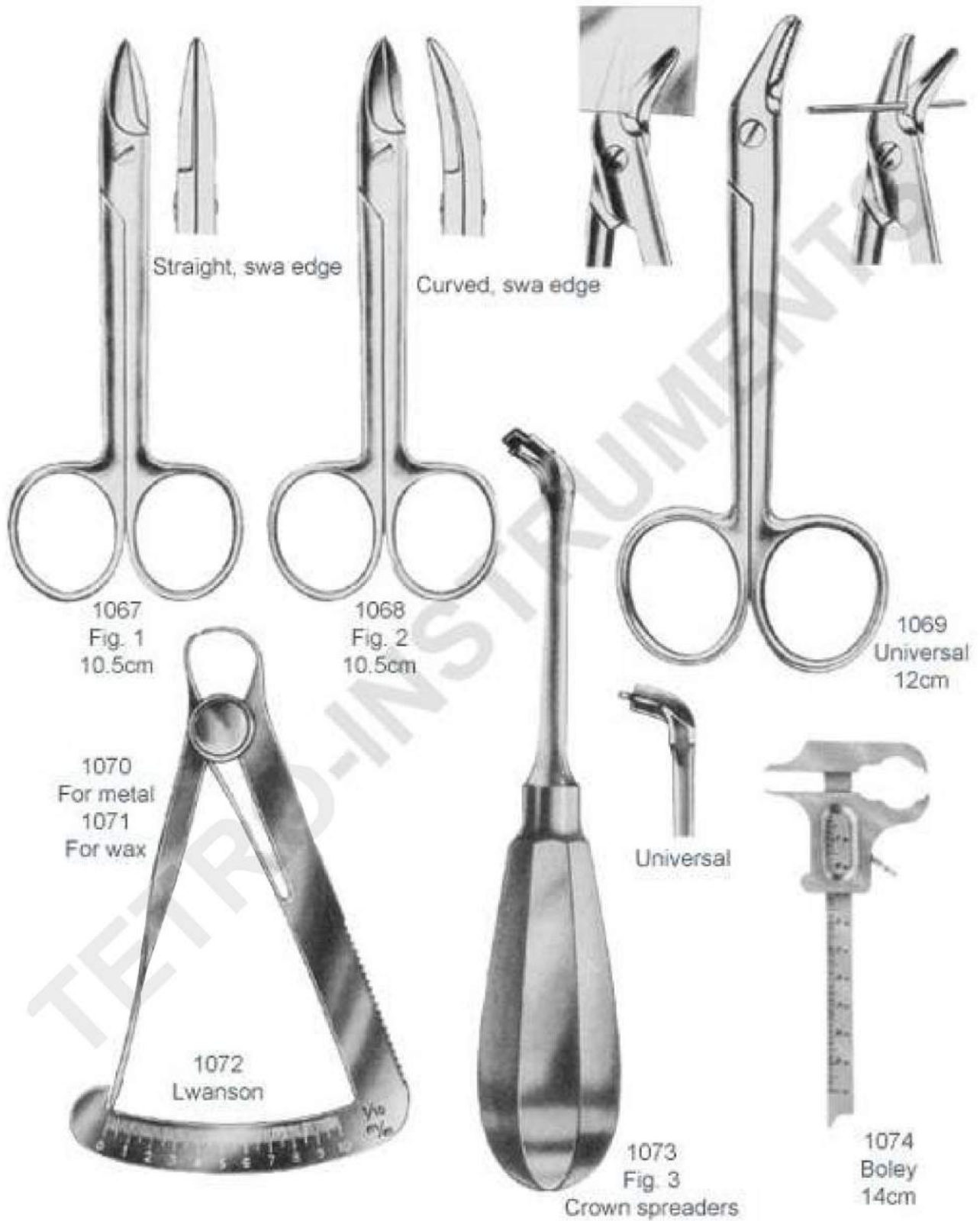



TETRO SURGICAL

Manufacturers & Exporters of Dental, Surgical & Beautycare Instruments.

Crown Instruments

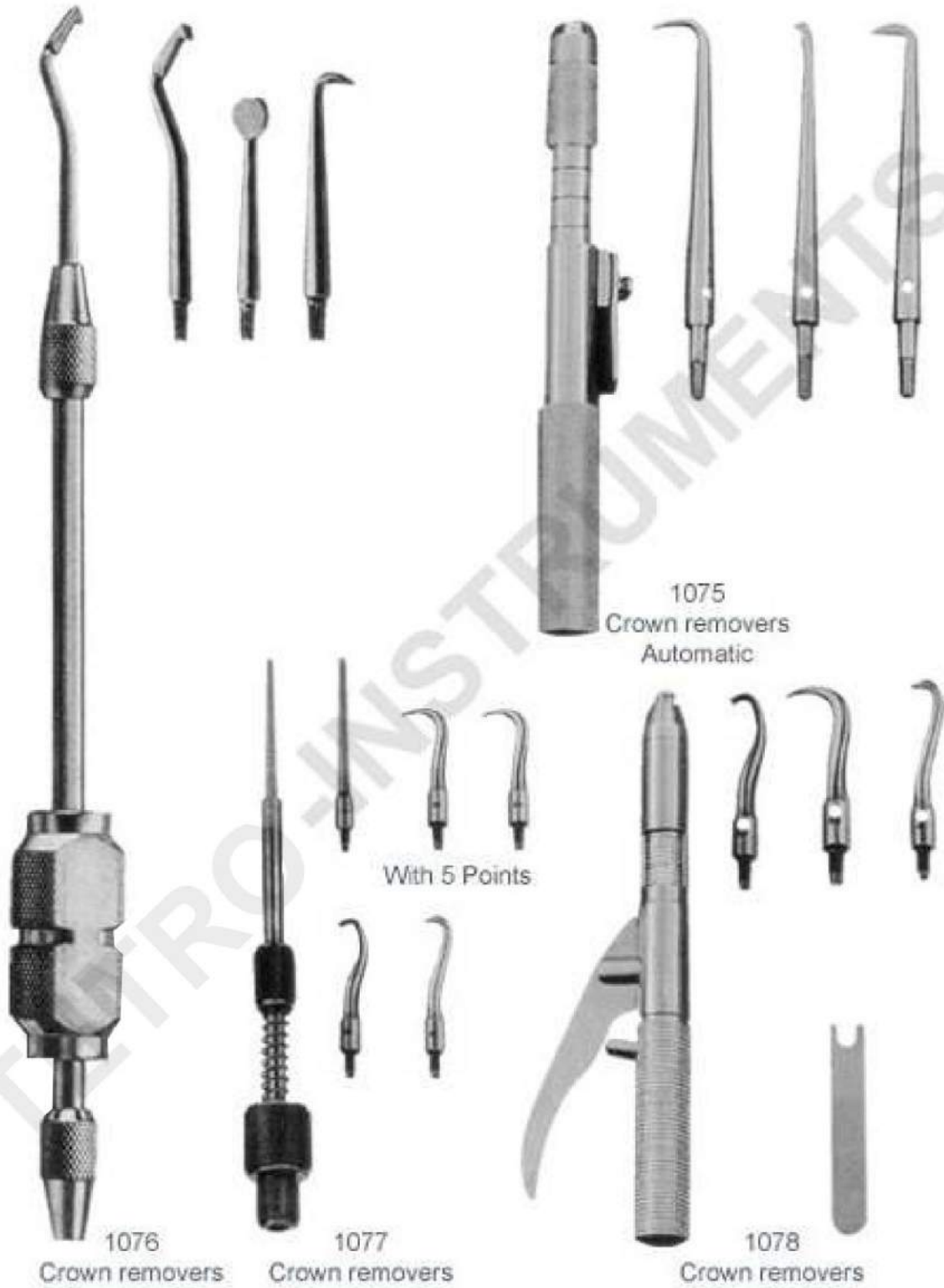



TETRO SURGICAL

Manufacturers & Exporters of Dental, Surgical & Beautycare Instruments.

Crown Instruments



1079
15cm



1080
Miller
15cm



1081
Crown Spreader

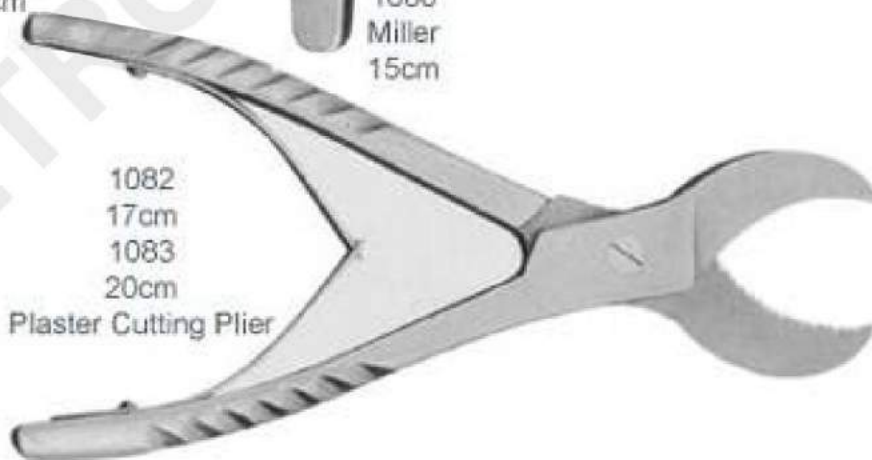

1082
17cm
1083
20cm
Plaster Cutting Plier



TETRO SURGICAL

Manufacturers & Exporters of Dental, Surgical & Beautycare Instruments.

Stainless Steel Impression Trays

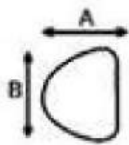
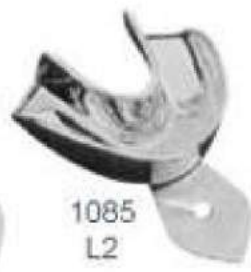

UPPER		U1	U2	U3	U4	U5
	A	62	60	53	54	52
B	63	75	73	69	68	

LOWER		L1	L2	L3	L4	L5
	A	63	61	57	60	53
B	62	81	78	74	71	

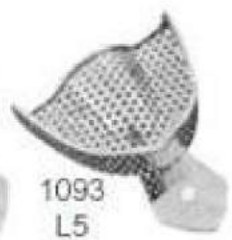
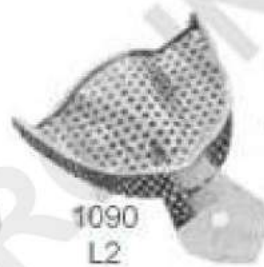
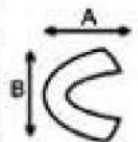



TETRO SURGICAL

Manufacturers & Exporters of Dental, Surgical & Beautycare Instruments.

Stainless Steel Impression Trays



1094
XL



1095
L



1096
M



1097
S



1094
XL



1095
L



1096
M



1097
S

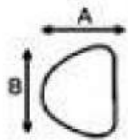

UPPER	XL	L	M	S
	A	70	67	64
B	79	78	70	73

All Dimension are in mm

LOWER	XL	L	M	S
	A	64	64	60
B	86	70	73	70

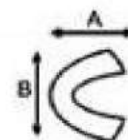

1098
XL



1099
L



1100
M



1101
S



1098
XL



1099
L



1100
M



1101
S

Perforated Full Denture Set of 8 225-011S



TETRO SURGICAL

Manufacturers & Exporters of Dental, Surgical & Beautycare Instruments.

Stainless Steel Impression Trays



All the above impression trays are available in these 4 sizes



LOWER		L1	L2	L3
	A	67	64	57
B	81	71	70	

All Dimension are in mm

LOWER		L1	L2	L3
	A	60	57	64
B	84	79	76	

All Dimension are in mm

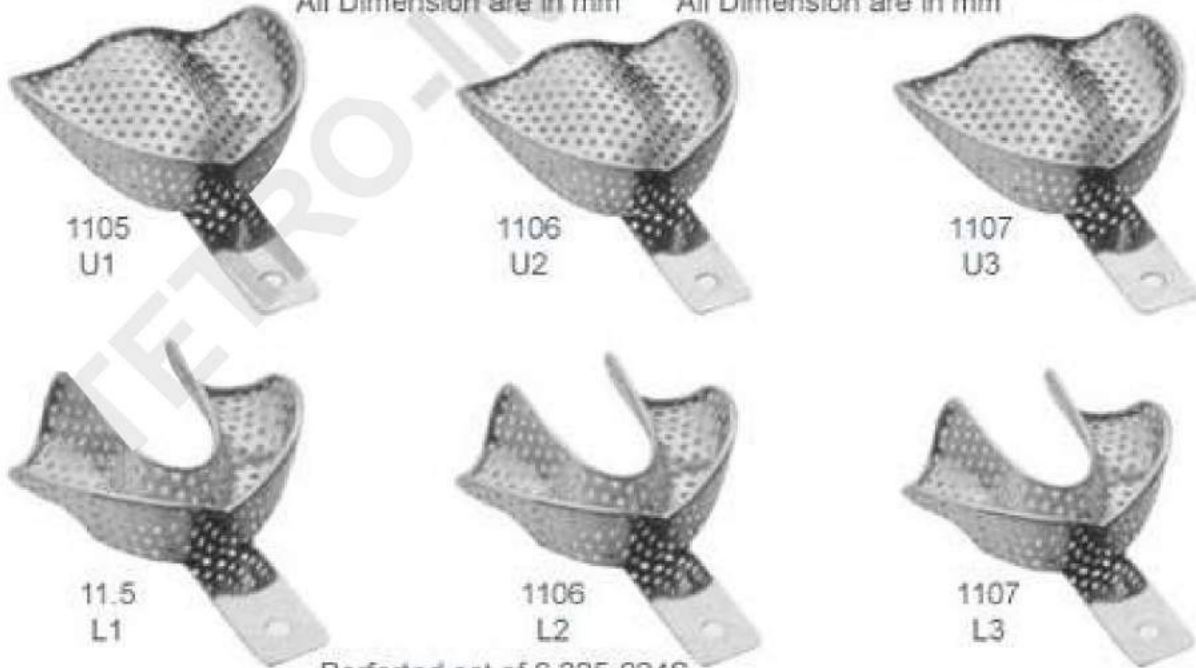

Perforated set of 6 225-024S



TETRO SURGICAL

Manufacturers & Exporters of Dental, Surgical & Beautycare Instruments.

Stainless Steel Impression Trays

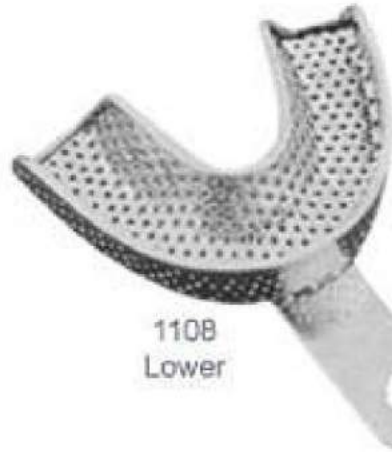

1108
Lower

English Pattern

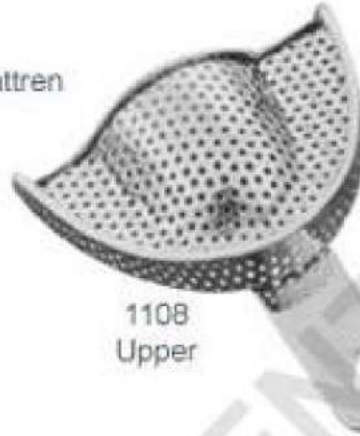

1108
Upper

Set of 8
222-026S

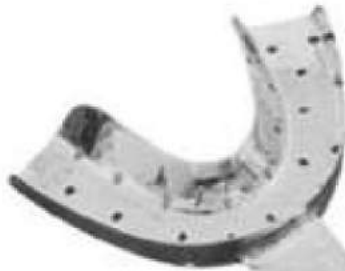

1109
Lower

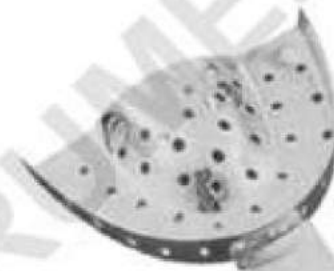

1109
Upper



1110
Lower



1110
Upper

All the above impression trays are available in these 4 sizes

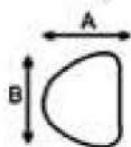

UPPER	Size	A	B	C
	0	67	50	12
	1	72	51	13
	2	78	55	15
	3	80	58	15

All Dimension are in mm

LOWER	Size	A	B	C
	0	70	50	12
	1	77	51	13
	2	77	55	15
	3	80	50	15

All Dimension are in mm



TETRO SURGICAL

Manufacturers & Exporters of Dental, Surgical & Beautycare Instruments.

Stainless Steel Impression Trays

Made of 18/8 Stainless Steel

Solid Full Denture set of 8
225-028S

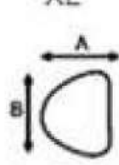

All the above impression trays are available in these 4 sizes

UPPER		XL	L	M	S
A		70	67	64	60
B		79	78	70	73

All Dimension are in mm.

LOWER		XL	L	M	S
A		64	64	60	57
B		66	70	73	70

All Dimension are in mm

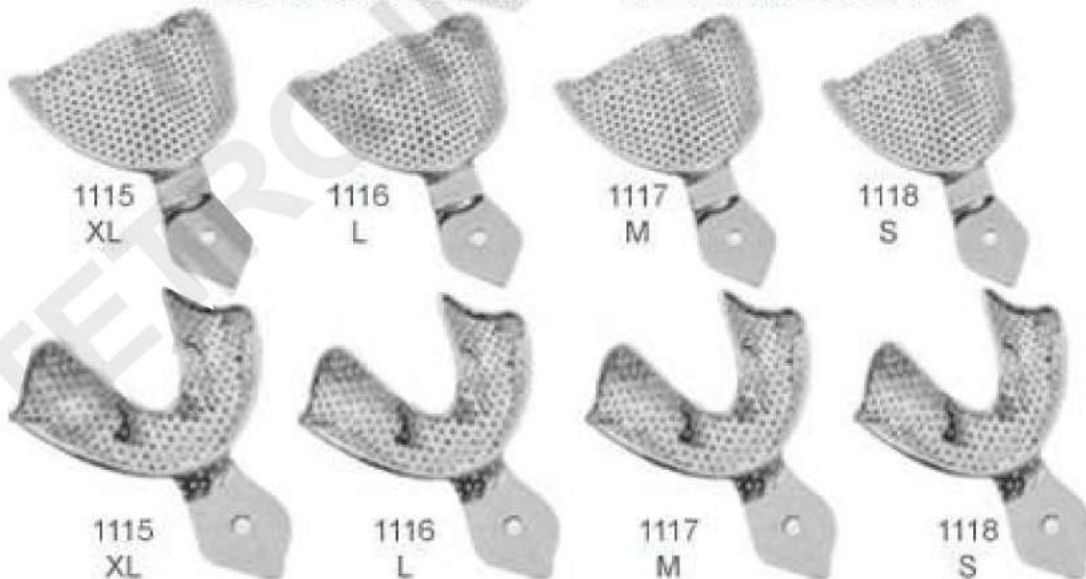

Preforted Full Denture Set of 8 225-035s



Stainless Steel Impression Trays

For crown & bridgework impression trays

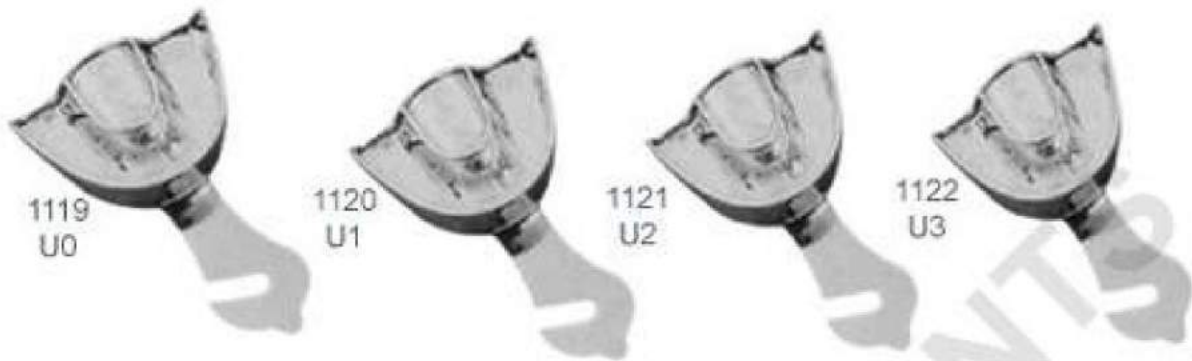

Upper Sizes 0, 1, 2, 3,
Depth of tray 19,9 mm
Height of palate 12,5 mm

Lower Sizes 0, 1, 2, 3,
Depth of the tray 12,9 mm

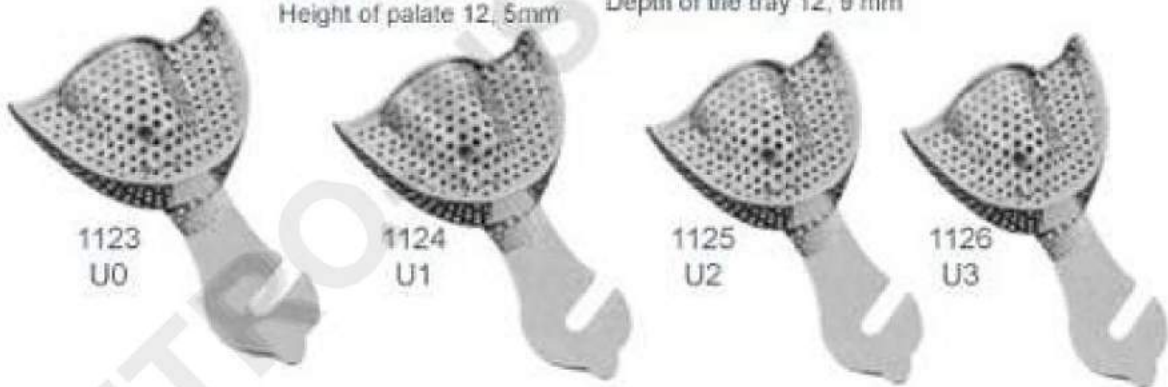

Preforted Full Denture Set of 8 225-035s



TETRO SURGICAL

Manufacturers & Exporters of Dental, Surgical & Beautycare Instruments.

Stainless Steel Impression Trays

Impression trays for crown & bridge work



1127
U1P



Solid

1127
L1p



1128 Perforated
U1p



1128
L1p



1129

For upper right jaw
for lower left jaw



1130

For upper right jaw
for lower left jaw



1131
Adjustable
Perforated



1131A
Adjustable
Perforated

Available in 4 size

1.....44mm 3.....60mm

2.....55mm 4.....65mm

Also available in solid pattern



TETRO SURGICAL

Manufacturers & Exporters of Dental, Surgical & Beautycare Instruments.

Stainless Steel Impression Trays

1132S

Complete Instrument tray with perforated base,
Lid & insert frame for 16 instruments

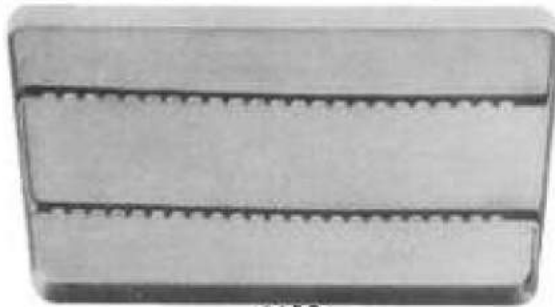

1132

Lid dimensions mm. 228-187-29



1133

Professional Base: Dimension 284-183-17

1125s

Complete instrument tray with solid base
lid & insert frame for 16 instruments

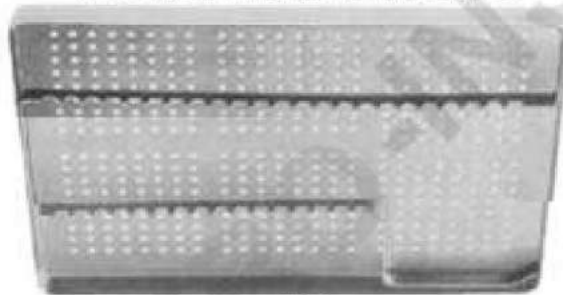

134

Lid Dimension 288-187-29mm

1137S

Complete Instrument tray with perforated base,
Lid & insert frame for 23 instruments

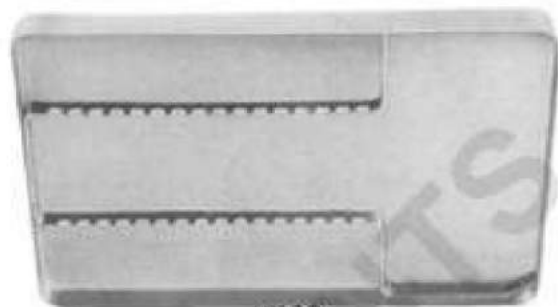

1133

Lid dimensions mm. 228-187-29



1137

Professional Base: Dimension 284-183-17

1139

Complete instrument tray with solid base
lid & insert frame for 23 instruments

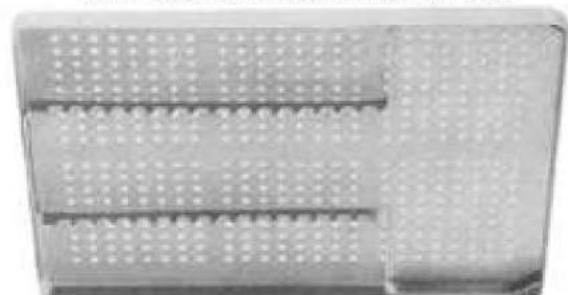

138

Lid Dimension 288-187-29mm



TETRO SURGICAL

Manufacturers & Exporters of Dental, Surgical & Beautycare Instruments.

Stainless Steel Impression Trays

Scallers Tray



1140

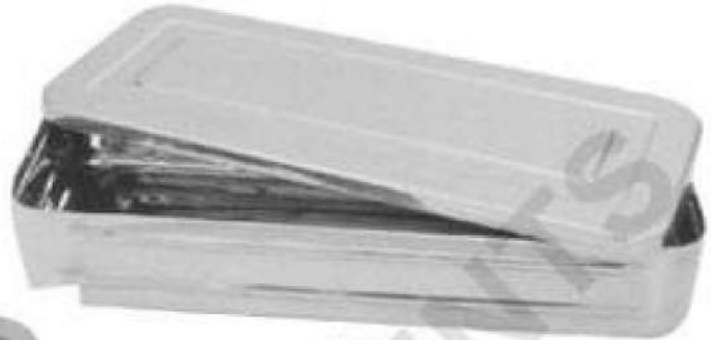

1141
6" x 10"
Without Lid



1142
6" x 8"
With lid



1143
6" x 8"
8" x 10"
10" x 12"
With lid



1144



1145

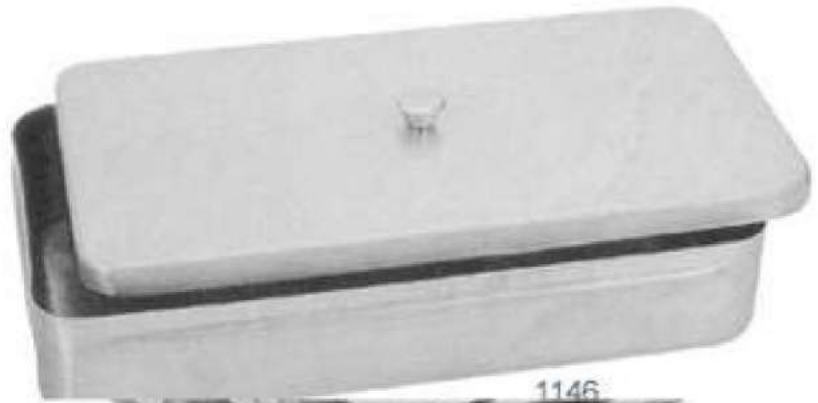

1146

1143
6" x 8"
8" x 10"
10" x 12"
With lid



TETRO SURGICAL

Manufacturers & Exporters of Dental, Surgical & Beautycare Instruments.

Stainless Steel Impression Trays



1147

Deep

2.25" - 2
4.75" - 2
5.5" - 2.5"
6.25" - 2.75"
7" - 3.5



1148
12" - 10" - 8" - 6"

Shallow



1149
6" - 9" 8" - 12"



1150
10" x 10"

Round bowls



1151
Cotton holder



1152

80 x 35mm
125 x 60mm



1153
Spint lamp



1154
Spint lamp



25 x 80mm
30 x 100mm
100 x 200mm
75 x 173mm

1155
Forceps



TETRO SURGICAL

Manufacturers & Exporters of Dental, Surgical & Beautycare Instruments.

Rubber Dam Clamps

Molar Clams Winged



1156
Fig. 30



1157
Fig. 31



1158
Fig. 51



1159
Fig. 138



1160
Fig. 139



1161
Fig. 15



1162
Fig. 18



1163
Fig. 24



1164
Fig. 25



1165
Fig. 26



1166
Fig. 28



1167
Fig. 206



1168
Fig. 207



1169
Fig. 208



1170
Fig. 209



1171
Fig. 22



1172
Fig. 27



1173
Fig. 29

Bicuspid Clams Winged



1174
Fig. 26A



1175
Fig. 28A



1176
Fig. 30A



1177
Fig. 31A



1178
Fig. 51A



1179
Fig. 27



1180
Fig. 29



1182
Fig. 60

Molar Clams Winged



1182
Fig. 200



1183
Fig. 201



1184
Fig. 202



1185
Fig. 203



1186
Fig. 204



1187
Fig. 205

Labia Clamps Winged



1188
Fig. 210

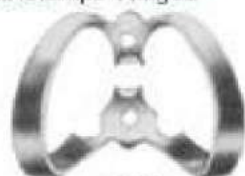

1189
Fig. 211



1190
Fig. 212

DENTAL



TETRO SURGICAL

Manufacturers & Exporters of Dental, Surgical & Beautycare Instruments.

+92 305 823 6257

✉ info@tetrosurgical.com 🌐 www.tetrosurgical.com

📍 Mohallah Muzaffar pur, Defence Road, Sialkot-Pakistan